



Double Chamber Vacuum Packaging

Models VP-NL-0100-L, 0300-L, 0063-L

Items 50000, 50001, 50002

Instruction Manual



Revised - 02/24/2022



Toll Free: 1-800-465-0234
Fax: 905-607-0234
Email: service@omcan.com
www.omcan.com



Table of Contents

Model VP-NL-0100-L / Model VP-NL-0300-L / Model VP-NL-0063-L

Section	Page
General Information -----	3 - 4
Safety and Warranty -----	4 - 5
Technical Specifications -----	6
Installation -----	6 - 7
Operation -----	7 - 14
Maintenance -----	14 - 18
Troubleshooting -----	19 - 20
Parts Breakdown -----	21 - 36
Electrical Schematics -----	37
Notes -----	38
Warranty Registration -----	39



General Information

Omcan Manufacturing and Distributing Company Inc., Food Machinery of America, Inc. dba Omcan and Omcan Inc. are not responsible for any harm or injury caused due to any person's improper or negligent use of this equipment. The product shall only be operated by someone over the age of 18, of sound mind, and not under the influence of any drugs or alcohol, who has been trained in the correct operation of this machine, and is wearing authorized, proper safety clothing. Any modification to the machine voids any warranty, and may cause harm to individuals using the machine or in the vicinity of the machine while in operation.

CHECK PACKAGE UPON ARRIVAL

Upon receipt of an Omcan shipment please inspect for external damage. If no damage is evident on the external packaging, open carton to ensure all ordered items are within the box, and there is no concealed damage to the machine. If the package has suffered rough handling, bumps or damage (visible or concealed), please note it on the bill of lading before accepting the delivery and contact Omcan within 24 hours, so we may initiate a claim with the carrier. A detailed report on the extent of the damage caused to the machine must be filled out within three days, from the delivery date shown in the shipping documents. Omcan has no recourse for damaged products that were shipped collect or third party.

Before operating any equipment, always read and familiarize yourself with all operation and safety instructions.

Omcan would like to thank you for purchasing this machine. It's of the utmost importance to save these instructions for future reference. Also save the original box and packaging for shipping the equipment if servicing or returning of the machine is required.

Omcan Fabrication et distribution Compañie Limité et Food Machinery d'Amerique, dba Omcan et Omcan Inc. ne sont pas responsables de tout dommage ou blessure causé du fait que toute personne ait utilisé cet équipement de façon irrégulière. Le produit ne doit être exploité que par quelqu'un de plus de 18 ans, saine d'esprit, et pas sous l'influence d'une drogue ou d'acohol, qui a été formé pour utiliser cette machine correctement, et est vêtu de vêtements de sécurité approprié. Toute modification de la machine annule toute garantie, et peut causer un préjudice à des personnes utilisant la machine ou des personnes à proximité de la machine pendant son fonctionnement.

VÉRIFIEZ LE COLIS DÈS RÉCEPTION

Dès réception d'une expédition d'Omcan veuillez inspecter pour dommages externes. Si aucun dommage n'est visible sur l'emballage externe, ouvrez le carton afin de s'assurer que tous les éléments commandés sont dans la boîte, et il n'y a aucun dommage dissimulé à la machine. Si le colis n'a subi aucune mauvaises manipulations, de bosses ou de dommages (visible ou cachée), notez-le sur le bond de livraison avant d'accepter la livraison et contactez Omcan dans les 24 heures qui suivent, pour que nous puissions engager une réclamation auprès du transporteur. Un rapport détaillé sur l'étendue des dommages causés à la machine doit être rempli dans un délai de trois jours, à compter de la date de livraison indiquée dans les documents d'expédition. Omcan n'a aucun droit de recours pour les produits endommagés qui ont été expédiées ou cueilli par un tiers transporteur.

General Information

Avant d'utiliser n'importe quel équipement, toujours lire et vous familiariser avec toutes les opérations et les consignes de sécurité.

Omcan voudrais vous remercier d'avoir choisi cette machine. Il est primordial de conserver ces instructions pour une référence ultérieure. Également conservez la boîte originale et l'emballage pour l'expédition de l'équipement si l'entretien ou le retour de la machine est nécessaire.

Omcan Empresa De Fabricacion Y Distribucion Inc. Y Maquinaria De Alimentos De America, Inc. dba Omcan y Omcan Inc. no son responsables de ningun daño o perjuicio causado por cualquier persona inadecuada o el uso descuidado de este equipo. El producto solo podra ser operado por una persona mayor de 18 años, en su sano juicio y no bajo alguna influencia de droga o alcohol, y que este ha sido entrenado en el correcto funcionamiento de esta máquina, y ésta usando ropa apropiada y autorizada. Cualquier modificación a la máquina anula la garantía y puede causar daños a las personas usando la máquina mientras esta en el funcionamiento.

REVISE EL PAQUETE A SU LLEGADA

Tras la recepcion de un envio Omcan favor inspeccionar daños externos. Si no hay daños evidentes en el empaque exterior, Habra el carton para asegurarse que todos los articulos solicitados estén dentro de la caja y no encuentre daños ocultos en la máquina. Si el paquete ha sufrido un manejo de poco cuidado, golpes o daños (visible o oculto) por favor anote en la factura antes de aceptar la entrega y contacte Omcan dentro de las 24 horas, de modo que podamos iniciar una reclamación con la compañía. Un informe detallado sobre los daños causados a la máquina debe ser llenado en el plazo de tres días, desde la fecha de entrega que se muestra en los documentos de envío. Omcan no tiene ningun recurso por productos dañados que se enviaron a recoger por terceros.

Antes de utilizar cualquier equipo, siempre leer y familiarizarse con todas las instrucciones de operación y seguridad.

Omcan quisiera darles las gracias por la compra de esta máquina. Es de la máxima importancia para guardar estas instrucciones para referencias en el futuro. También guarde la caja original y el embalaje para envío del equipo si el mantenimiento o la devolución de la máquina es necesaria.

Safety and Warranty

The manufacturer of this equipment accepts no liability whatsoever for damage or injury caused by failing to adhere to the directions and instructions in this manual, or through carelessness during the installation, use, maintenance and repair of the machine identified on the front of this document, or any of its accompanying options or components.

The owner of the machine is fully responsible at all times for the adherence to the locally applicable safety regulations and guidelines. Obey all safety instructions and guidelines as provided in this manual.



Safety and Warranty

INTENDED USE OF THE MACHINE

The machine is designed for vacuum packaging of food or other products for 8 hours a day, 5 days a week. Any other or extended use is not in accordance with this purpose and the manufacturer accepts no liability for any resulting damage or injury. Only use this machine while in perfect technical condition in accordance with the above mentioned purpose.

Safety Measures

The machine is equipped with the following standard safety devices:

- Short-circuit and overload safety.
- Pump fan guards.

All safety devices must be correctly installed and may only be removed to accommodate maintenance and repair activities by trained and authorized service personnel. The machine may never be operated while safety measures are incomplete, deactivated or absent. The safety devices may never be by-passed.

RESIDENTIAL USERS: Vendor assumes no liability for parts or labor coverage for component failure or other damages resulting from installation in non-commercial or residential applications. The right is reserved to deny shipment for residential usage; if this occurs, you will be notified as soon as possible.

1 YEAR PARTS AND LABOR WARRANTY

Within the warranty period, contact Omcan Inc. at 1-800-465-0234 to schedule an Omcan authorized service technician to repair the equipment locally.

Unauthorized maintenance will void the warranty. Warranty covers electrical and part failures, not improper use.

Please see <https://omcan.com/disclaimer> for complete info.

WARNING:

The packaging components are classified as normal solid urban waste and can therefore be disposed of without difficulty.

In any case, for suitable recycling, we suggest disposing of the products separately (differentiated waste) according to the current norms.

DO NOT DISCARD ANY PACKAGING MATERIALS IN THE ENVIRONMENT!

Technical Specifications

Model	VP-NL-0100-L	VP-NL-0300-L	VP-NL-0063-L
Seal Length	24.4" / 620mm x 4	32.2" / 920mm x 4	23.6" / 600mm x 4
Vacuum Pump	100 m ³	300 m ³	63 m ³
10 Programmable Control	YES		
Maximum Product Height	9" / 230mm	10.6" / 270mm	7" / 180mm
Useful Chamber Size	20.5" x 24.4" x 9" 520 x 620 x 229mm	34.3" x 36.2" x 10.6" 870 x 920 x 270mm	20" x 24" x 7" 508 x 610 x 178mm
Power Consumption	4.4 kW	6.2 - 9.7 kW	4.4 kW
Electrical	190-240 / 60Hz / 3	220-380V / 60Hz / 3	190-240 / 60Hz / 3
Weight	770 lbs. / 350 kgs.	1584 lbs. / 720 kgs.	528 lbs. / 240 kgs.
Dimensions	36.2" x 56.7" x 47.4" 920 x 1440 x 1205mm	50" x 78.7" x 49" 1270 x 2000 x 1245mm	28.3" x 53" x 41" 720 x 1345 x 1041mm
Item Number	50000	50001	50002

Installation

GENERAL

- Level the machine on a flat firm surface.
- Position the machine in such a manner that the pump is unobstructed and properly ventilated.
- Engage the locks on the wheels, if so equipped.
- Check the oil level in the pump; add oil if necessary.

Never operate the machine when the oil level is low. It is recommended to change the oil at least every 2 months.

TURNING ON MACHINE

- If so equipped, like some mobile and double-chamber models, turn on the main power switch on the back of the machine.
- Push the on/off button on the control panel of the machine.

GAS CONNECTION FOR MAP APPLICATIONS (MODIFIED ATMOSPHERIC PACKAGING)

- Connect the gas supply line to the inlet on the back of the machine.
- Maximum pressure: 1 bar.
- Anchor the gas cylinders securely to prevent them from falling over.
- Make sure that the work area is well-ventilated.
- To assure that you use the appropriate gas for your application, consult your dealer or gas supplier.
- Assure a good connection and use high-quality materials.

Installation

COMPRESSED AIR CONNECTION FOR ADDITIONAL SEALING PRESSURE

- Additional sealing pressure is usually recommended for MAP applications only.
- The M40-M80 and the L10-L60 models with the option Gas/MAP are standard equipped with a compressed air inlet.
- Extra sealing pressure is not necessary and not available for the Table-Top, M10, M20, M30.
- Consult your dealer for installation details.
- Maximum pressure: 1 bar.
- Assure a good connection and use high-quality connector.

Operation

DIGITAL CONTROL WITH LCD DISPLAY

Some Henkovac vacuum machines have a control system with just one Program (P1). Other machines have an optional expanded control system, which can accommodate up to 9 custom programs (P1-9).

ONE-PROGRAM CONTROL SYSTEM

Henkovac machines with the One-Program control system can be programmed for the following 2 functions:























1. Vacuum time (seconds).
 2. Sealing time (seconds).
- The values for vacuum and sealing times are selected by the user and saved in program P1.
 - During operation, the LCD display will show symbols to indicate the active function and the progress of the packing cycle.
 - The actual vacuum pressure is indicated by the analog vacuum gauge.



PLUG AND PLAY

- When turning on the machine for the first time:
 - Running time of the vacuum pump is pre-set at 30-40 seconds and the sealing time at 2 seconds.Vacuum is indicated on the analog vacuum gauge.
- When turning on the machine after that, program P1 will contain the most-recently used settings.
- The vacuum and sealing times are easily adjusted to match the needs for the application.

Operation

OPERATING THE MACHINE WITH ONE-PROGRAM CONTROL SYSTEM

	<p>On: Turns the machine on:</p> <ul style="list-style-type: none"> The machine will start up in the most-recently used program. The pump of a machine with a transparent cover will start when the cover is closed. <p>Off: Turns the machine off:</p> <ul style="list-style-type: none"> When pressing the  button once, the  symbol will start blinking and the pump will stop after about 4 seconds. When pressing the  button a second time, the pump will stop immediately. Closing the cover will initiate the cool-down phase; the machine will complete a number of vacuum cycles before turning off automatically.
	<p>Stop-function:</p> <ul style="list-style-type: none"> Stops the machine at any point in the packing cycle and aerates the chamber. <p>Reset-function:</p> <ul style="list-style-type: none"> While programming, resets the program value to its original setting. Press the menu button  to return to the Home menu
	<p>Stops the current function and initiates the next step in the cycle:</p> <ul style="list-style-type: none"> By pressing the  of the sealing button , the vacuum function stops and the program jumps to the sealing function. While packing sauce or soup, the package may be sealed as soon as product boiling is detected.
	<p>Entering the desired vacuum time : By pressing the + or – of the vacuum button, the vacuum time can be increased or decreased.</p> <p>The selected value is confirmed and saved by pressing the menu button :</p> <ul style="list-style-type: none"> Press the  button to reset the original value.
	<p>Entering the desired sealing time :</p> <ul style="list-style-type: none"> By pressing the + or – of the sealing button, the sealing time can be increased or decreased. <p>The selected value is confirmed and saved by pushing the menu button :</p> <ul style="list-style-type: none"> Press the  button to reset the original value.
	<p>Menu Button:</p> <ul style="list-style-type: none"> Confirms and saves the entered values for vacuum and sealing times. Returns to the Home menu.
	<p>When turning off the machine with the  button, the  symbol will start blinking:</p> <ul style="list-style-type: none"> The pump will stop after about 4 seconds. Press the  button a second time and the pump will stop immediately. Close the lid; the machine initiates the cool-down phase and perform a number of vacuum cycles before turning off automatically. These additional cycles allow any moisture in the oil of the pump to evaporate. This increases the longevity of the machine and minimizes the need for oil changes and pump maintenance.

	<p>Service Symbol:</p> <ul style="list-style-type: none">• After a number of operating hours or packing cycles, the service symbol will briefly appear on the display when the machine is turned on. In addition, the display indicates how many hours or cycles remain before an oil change is required.• Except for regularly changing the oil in the pump (important!), the machine requires little other routine maintenance.• To reset the service interval counters after the oil change: Start machine  and while the display shows the hours or cycles, press and hold the  button.
---	---

TEN-PROGRAM CONTROL SYSTEM

In addition to vacuum and sealing times, Henkovac machines with a Ten-Program control system may be programmed for several additional functions. Each of the 9 customizable programs is either:

1. Time controlled.
2. Sensor controlled.

TIME-BASED OPERATION (VACUUM GAUGE: MBAR)

- The values for vacuum and sealing time, as well as the values for several optional functions, are selected by the customer and saved in any of 9 customizable programs P1-9.
- When operating a packaging machine with a time-based program, the actual vacuum pressure is indicated by the analog vacuum gauge. The number of seconds of vacuum time remaining is shown on the LCD display.

PLUG AND PLAY

- When turning on a time-based machine for the first time, it will start up in the PA program AUTOMATIC. This is a pre-set factory program with 30-40 seconds vacuum time and 2 seconds of sealing time.
- When turning on the machine after that, it will start up in the most-recently used program.

OPTIONAL INSTALLATION OF A SENSOR OR SOFT-AIR

- A machine with a time-based control program can be upgraded to sensor-based operation at a later date by installing the optional sensor kit.
- The Soft-Air feature can also be installed at a later date by ordering the optional soft-air kit.

SENSOR-BASED OPERATION (DIGITAL DISPLAY: MBAR)

- When operating a packaging machine with a sensor-based program, the actual vacuum pressure is digitally shown on the LCD display in mbar (standard setting) or in % vacuum.

PLUG AND PLAY





















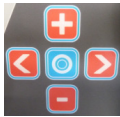





- When turning on a sensor-based machine for the first time, it will start up in the PA program AUTOMATIC. This is a pre-set factory program with 5 mbar of vacuum and 2 seconds of sealing time.
- When turning on the machine after that, it will start up in the most-recently used program.











OPTIONAL INSTALLATION OF SOFT-AIR

- The Soft-Air feature can also be installed at a later date by ordering the optional soft-air kit.

Operation

OPERATING THE MACHINE WITH TEN-PROGRAM CONTROL SYSTEM

	<p>On: Turns the machine on:</p> <ul style="list-style-type: none"> The machine will start up in the most-recently used program. The pump of a machine with a transparent cover will start when the cover is closed. <p>Off: Turns the machine off:</p> <ul style="list-style-type: none"> When pressing the  button once, the  symbol will start blinking and the pump will stop after about 4 seconds. When pressing the  button a second time, the pump will stop immediately. Closing the cover will initiate the cool-down phase. The machine will complete a number of vacuum cycles before turning off automatically.
	<p>Stop-function:</p> <ul style="list-style-type: none"> Stops the machine at any point in the cycle and aerates the chamber. <p>Reset-function:</p> <ul style="list-style-type: none"> While programming, resets the program value to its original setting. Press the menu button  to return to the Home menu. <p>Back function:</p> <ul style="list-style-type: none"> While reviewing programmed values, returns to the previous selection.
	<p>Stops the active function and initiates the next step in the cycle:</p> <ul style="list-style-type: none"> While the machine is running, exits the active function and jumps to the next step in the cycle. While packing sauce or soup, the package may be sealed as soon as product boiling is detected.
	<p>Menu Button:</p> <ul style="list-style-type: none"> Toggles between Home menu  and Settings menu . Save Function: During programming, confirms and saves the entered program values and returns to the Home menu. Return Function: Returns to the Home menu.
	<p>Review program values:</p> <ul style="list-style-type: none">   Cycles through programs P1 to P9, as well as PA and P H2O.  Displays the programmed value for each function; the function being reviewed will be blinking.   Displays the value for the next function.  Returns to the Home menu.
	<p>Adjust program values and turn functions ON/OFF:</p> <ul style="list-style-type: none">   Forward or back; adjusted values are saved right away.   Increases or decreases function values.  Turns functions ON/OFF; specific functions, like soft-air, clean cut seal, etc., are turned either on or off. If the function is turned on, the value may be adjusted by pressing the  and  buttons.  Resets the original value.  Saves changes and returns to the Home menu.

	<p>Multi-Functional button: Performs various functions, depending on the active menu:</p> <p>Home menu  :</p> <ul style="list-style-type: none"> • No effect while in the PA program. • For programs P1-9, displays the entered values. <p>Settings menu  :</p> <ul style="list-style-type: none"> • For specific functions, like soft-air, clean cut seal etc., the  button is used to turn the function ON/OFF.
<p>P1 – P9</p>	<p>Programs 1 through 9:</p> <ul style="list-style-type: none"> • Each program may be customized by turning certain functions on or off and by adjusting the function values.
<p>PA AUTOMATIC</p>	<p>PA - Automatic:</p> <ul style="list-style-type: none"> • Program with factory settings for vacuum and sealing functions, which is activated when turning on the machine for the first time.
<p>P H₂O</p>	<p>P H₂O – Program:</p> <ul style="list-style-type: none"> • To be used when packing liquids or semi-liquids, like sauces and soups. • Program jumps to the sealing function as soon as product boiling is detected; this prevents product loss through spillage and evaporation.
	<p>When turning off the machine with the  button, the  symbol will start blinking on the LCD display:</p> <ul style="list-style-type: none"> • The pump will stop after about 4 seconds. • Press the  button for a second time and the pump will stop immediately. • Close the lid; the machine will initiate the cool-down phase and perform a number of vacuum cycles before turning off automatically. • These additional cycles allow any moisture in the oil of the pump to evaporate. This increases the longevity of the machine and minimizes the need for oil changes and pump maintenance.
	<p>Service Symbol:</p> <ul style="list-style-type: none"> • After reaching a certain number of operating hours or packing cycles, the service symbol will briefly appear on the display when turning on the machine. In addition, the display indicates how many hours or cycles remain before an oil change is required. • Except for regularly changing the oil in the pump, the machine requires little other routine maintenance. • After reaching the service limit, the display will indicate the negative number of exceeded operating hours or cycles. • To reset the service interval counters after the oil change: Start machine  and while the display shows the hours or cycles, press and hold the  button to reset.

PROGRAMMING THE MACHINE

ONE-PROGRAM CONTROL SYSTEM

- The One-Program control system is standard on the S20, S30, S40, S50, M10, M30 (with 21m³ pump).
- The One-Program control system is time-based.
- The Ten-Program control system (time or sensor) is optional for these models, except for S20.



Operation

THE ONE-PROGRAM CONTROL SYSTEM PROVIDES ONLY ONE PROGRAM (P1)

- There is no memory to store additional values.
- The machine starts with the values that were most-recently used.
- The pump starts upon closing of the cover and stops when it is reopened.

PROGRAMMABLE FUNCTIONS





The following function values may be customized for P1:

-  Vacuum time: in seconds.
-  Sealing time: in seconds.





PROGRAMMING

1. Turn the machine on by pressing the on/off button.
 - a. The factory setting for the vacuum time is 30-40 seconds.
 - b. The factory settings for the seal time is 2 seconds.





REVIEWING VACUUM TIME AND SEALING TIME

1. Press the  button to display the programmed vacuum time the vacuum time is pre-set at the factory.

2. Press the  button to display the programmed sealing time the sealing time is pre-set at the factory at 2 seconds.





ADJUSTING VACUUM TIME FOR P1

1. Press twice on the  or  button.
 - After pressing once, the programmed value is displayed.
 - After pressing twice, the  symbol will start blinking and the value may be adjusted.
2. Save the new value by pressing the menu button.
3. To retain the original value, press the  button.
4. Exit the program by pressing the menu button.

ADJUSTING SEALING TIME FOR P1

1. Press twice on the  or  button.
 - After pressing once, the programmed value is displayed.
 - After pressing twice, the  symbol will start blinking and the value may be adjusted.
2. Save the new value by pressing the menu button.
3. To retain the original value, press the  button.
4. Exit the program by pressing the menu button.

TURNING OFF MACHINE

1. Turn the machine off by pressing the  button.
2. The  symbol on the display will start blinking.
3. Push the  button a second time and the pump will stop immediately.
4. If no action is taken the pump turns off after 4 seconds.
5. Close the cover and the machine will initiate the cool-down phase and perform a number of vacuum cycles

while the cover stays closed and the machine will turn off automatically after about 15 minutes.







- These cycles are necessary to cool down the machine and to allow any moisture in the oil of the pump to evaporate.

TEN-PROGRAM CONTROL SYSTEM





- The Ten-Program control system is standard time-based on the M20, M40-M80, L01-L60.
 - Sensor-based operation is an option, which can be installed at a later date.
- The Ten-Program control system provides:
 - 9 customizable programs (P1-P9).
 - Program PA; this is an - Automatic Program – Pre-set at the factory at a vacuum time of 30-40 seconds (or 5 mbar for a sensor-based program) and a sealing time of 2 seconds.
- Program P H2O for liquid products.
 - When turning on the machine, the pump will start. After about 15 minutes of inactivity, the pump will stop automatically.

PROGRAMMABLE FUNCTIONS





The following functions may be customized for each program P1-P9:

-  **Vacuum time:** in seconds or mbar (only with sensor).
-  **Sealing time:** in seconds.
-  **Vacuum Plus:** on/off, in seconds.
-  **Gassing:** on/off, in seconds or mbar (only with sensor).
-  **Clean Cut Controlled (CCC) Seal:** on/off, in seconds.
-  **Soft-Air:** on/off, in seconds or mbar (only with sensor).
-  **Multi-cycle:** on/off, in number of cycles.

REVIEWING FUNCTION VALUES FOR P1-P9

1. Turn the machine on by pushing the  button.
2. The most-recently used program will be indicated.
3. All selected functions for this program are indicated at the bottom of the display.
4. To review the values for these functions, push the  button; use the  button to display each function value.
5. The values cannot be changed; this can only be done in the Settings menu.
6. Push the  button to return to the Home menu.

PROGRAMMING AND ADJUSTING VALUES FOR P1-P9





1. Select the program to be set up or adjusted.
2. Push the menu button to access the Settings menu.
3. All functions for the selected program are indicated at the bottom of the display.
4. Push the  button to select the blinking function to be adjusted.
5. Adjust the value of the selected function with the  button.
6. Press the  button to reset all functions to their original values.
7. Select the next function with the  button.

Operation





8. Press the menu button to save the entered values and to return to the Home menu.

TURNING PROGRAM FUNCTIONS ON/OFF

The following functions can be turned ON/OFF for each program P1-P9:

-  **Vacuum Plus:** on/off, in seconds.
-  **Gassing:** on/off, in seconds or in mbar (only with sensor).
-  **Clean Cut Controlled (CCC) Seal:** on/off, in seconds.
-  **Soft-Air:** on/off, in seconds or in mbar (only with sensor).
-  **Multi-cycle:** on/off, in number of cycles.

ADJUSTING ON/OFF FUNCTION VALUES

1. Press the menu button to select the Settings menu.
2. Use the  button to select the blinking function to be adjusted.
3. Press the  button to select the desired value.

4. Press the  button to reset all functions to their original values.
5. Select the next function with the  button.
6. Push the menu button to store all selected values and to return to the Home menu.

TURNING OFF MACHINE

- Follow the same procedure as for the One-Program control system.

Maintenance

GENERAL

Regular maintenance prevents equipment malfunctions and prolongs the life of the machine. In addition, it optimizes sanitary conditions.

- Always have a certified Henkovac dealer carry out repair and maintenance activities.

WARNING

- During maintenance activities, always turn the machine off at the main switch and/or unplug it from the electrical outlet.

ATTENTION



Observe the recommended service intervals. Overdue maintenance may lead to costly repairs and overhauls, and may void the equipment warranty.

- After reaching a programmed number of operating hours or packing cycles, the service symbol  will briefly appear on the display when the machine is started up. In addition, the display will indicate how many hours or cycles remain before an oil change is required.



- After passing the service limit, the display will indicate the negative number of excess operating hours or cycles.

VACUUM PUMP

To protect the vacuum pump, proper maintenance is important. Carry out the following tasks carefully:

- Check the vents and clean as necessary before turning on the machine to assure proper cooling of the pump.
- When the air filter is saturated with oil, an oil mist may be expelled; replacement of the filter is required.
- Use the cool-down/dehumidification feature. When turning off the machine  and closing the cover , the pump continues to run for some time. Any moisture in the oil of the pump will evaporate during this phase. This increases the longevity of the machine and minimizes the need for oil changes and pump maintenance.
- Check the oil level regularly and add as needed.
- Change the oil when the service symbol  appears on the display.

NOTE

To reset the service interval counters after the oil change: Start machine  and while the display shows the hours or cycles, press and hold the  button.

ADDING AND CHANGING THE PUMP OIL

WARNING

The operating temperature of the pump is 70° C / 158° F or higher. Wear gloves when servicing the pump or let it cool off sufficiently to prevent injuries.

ADDING OIL

1. Remove the oil filler cap
2. Add oil up to the maximum-level mark; use oil according to DIN 51506, lubrication oil group VC. When in doubt, consult your dealer.
3. Replace the oil filler cap.
4. After several packing cycles, check the oil level and add as needed.

CHANGING OIL

1. Remove the oil drain plug and drain the oil.
2. Replace the drain plug.
3. Remove the oil filler cap.
4. Add the correct oil up to the maximum-level mark.
5. Replace the oil filler cap.
6. To reset the service interval counters after the oil change: Start machine and while the display shows the hours or cycles, press and hold the  button.

NOTE

Collect the oil to have it processed and recycled according to the locally applicable regulations.

Maintenance

SEAL BEAMS AND COUNTER BEAMS

To achieve a quality seal, it is necessary that the seal beam and counter beam are in good condition.

1. Clean the seal and counter beams daily with a dry cloth.
2. Replace the Teflon tape on the seal beam if damaged and replace the sealing wire if kinked.
3. Replace the silicone rubber seal if it is burned in.

Depending on the type of machine, there are three seal beam versions:

1. Single-seal beam (T2).
2. Stainless steel seal beam.
3. Aluminum seal beam.

SINGLE-SEAL BEAM

REMOVE THE SEALING WIRE AND TEFLON TAPE AS FOLLOWS:

1. Grab the seal beam in the middle and pull it straight up and out of the machine.
2. The beam is held in place by 2 pins; some force may be necessary to loosen the beam.
3. Remove the brown Teflon tape that is applied to the seal beam.
4. Remove the two screws on the underside of the seal beam; this releases the sealing wire.
5. Clean the seal beam thoroughly and remove any glue residue off the Teflon tape.

NOTES

- Check the condition of the tensioning springs at both ends of the seal beam; replace if necessary.
- These springs maintain tension on the sealing wire.
- Using the seal beam without the springs may cause sealing wires to break.

INSTALL THE SEALING WIRE AND TEFLON TAPE AS FOLLOWS:

1. Position the sealing wire across the beam and fasten it on one side with a small bolt.
2. Apply tension on the wire by pulling it with a pair of pliers.
3. Fasten the wire on the opposite end of the beam with the second bolt and cut the wire to length; the ends of the sealing wire must be long enough to make electrical contact with the pins in the vacuum chamber.
4. Apply the Teflon tape smooth and tight over the seal beam; make sure that the beam is clean and free of grease.
5. Re-install the beam in the vacuum chamber; check to make sure that the ends of the sealing wire make contact with the steel pins.

ALUMINUM/STAINLESS STEEL SEAL BEAM

REMOVE THE SEALING AND CUTTING WIRES AS FOLLOWS:

1. Remove the old wires by pulling them loose from the seal beam contacts.
2. Loosen the clamp screws and remove the seal beam from the U-profile.
3. Remove the Teflon tape from the seal beam.
4. Remove the mounting plates on both ends of the seal beam by loosening the screws; this releases the sealing wires and/or sealing and cutting wires.
5. Clean the seal beam thoroughly.

NOTES

- After removal of the wires, check the strips of fiber glass for damage; replace if necessary.
- Check the condition of the tensioning springs at both ends of the seal beam; replace if necessary.
- Using the seal beam without the springs may cause the sealing wires to break.
- Check contact plate for damage; replace if necessary.

INSTALL THE SEALING AND CUTTING WIRES AS FOLLOWS:

1. If necessary, install new strips of fiber glass on the seal beam.
2. Insert the new wires behind one of the mounting plates and tighten the screws; make sure that the end of the wires line up with the bottom edge of the mounting plate.
3. Position the wires across the seal beam and loosely install the second mounting plate.
4. Carefully clamp the seal beam upside down in a bench vice.
5. Pull the wires as tightly as possible with a pair of pliers and secure the second mounting plate by tightening the screws.

NOTE

1. The wires can be further tightened by slightly loosening the screws of one of the mounting plates.
2. Pull the wires one-by-one tighter with a pair of pliers.
3. Re-tighten the screws after the correct tension has been achieved.
4. Cut the end of the wires flush with the bottom edge of the mounting plate.
5. Apply the Teflon tape smooth and tight over the seal beam without creases. Make sure that the beam is clean and free of grease.
6. Re-install the seal beam in the vacuum chamber and re-connect the wires.

ALUMINUM T-SHAPED SEAL BEAM

REMOVE THE SEALING WIRES AS FOLLOWS:

1. Remove the seal beam from the machine.
2. Remove the Teflon tape.
3. Loosen the screws on both sides of the beam; this will release the sealing wires.
4. Clean the seal beam thoroughly.

INSTALL THE SEALING WIRES AS FOLLOWS:

1. Apply new fiber glass to the beam if necessary.
2. Place new wires on the beam and fasten them on one side with mounting plates; tighten the screws.
3. Position the wires across the beam.
4. Fasten mounting plates; tighten screws.
5. Carefully clamp the beam in a bench vice.
6. Pull the wires as tightly as possible with a pair of pliers.
7. Secure the mounting plates with the screws.

NOTES

- Check the strip of fiber glass for damage and replace if necessary.
- Check the springs and replace if necessary.
- Using the seal beam without the springs may cause the sealing wires to break.

Maintenance

APPLYING TEFLON TAPE TO SEAL BEAM

1. Position the new Teflon tape on the seal beam and cut out the corners.
2. Remove the protective backing from the Teflon tape.
3. Apply the new tape to the seal beam; the tape has an adhesive strip on both sides.
4. Slide the seal beam onto the pins in the vacuum chamber (machines with transparent cover).
5. Slide the seal beam in the holder of the cover, tighten the mounting screws, and re-connect the wires (machines with metal cover).

NOTE

- The Teflon tape must not adhere to the tension blocks.

REPLACING SILICONE RUBBER SEAL OF COUNTER BEAM

The rubber seal is clamped in the counter beam. Replace the counter beam seal as follows:

1. Pull the old rubber seal from the groove in the counter beam.
2. Clean the groove.
3. Evenly press the new rubber seal into the groove and make sure that it does not stick out at either end of the counter beam.

RUBBER SEAL OF VACUUM CHAMBER COVER

To assure that the vacuum chamber is properly sealed, it is important that the rubber seal is in good condition and is not damaged. Replace the cover seal as follows:

1. Copy the length of the original rubber seal.
2. Pull the original rubber seal from the groove.
3. Clean the groove.
4. Evenly press the rubber seal into the groove; position the ends of the seal tightly against each other to prevent leakage.

STRUTS, DAMPERS AND SPRINGS

- Machines with transparent covers are equipped with gas struts to open the cover.
- Machines with metal covers are equipped with oil dampers and springs to open the cover.
- Have the struts, dampers and springs checked by your dealer once every 5 years and have them replaced as necessary.
- Have the gas struts replaced if the lid no longer opens properly.

VACUUM HOSES AND TUBES

- Check the vacuum hoses and tubes for kinks, tears and porosity; replace if necessary.

Troubleshooting

Fault/Symptom	Possible Cause	Remedy
Machine does not work.	The machine is not plugged in.	Plug the machine into the electrical outlet.
	The ground fault safety in the electrical panel has tripped.	Check the electrical panel.
	A fuse in the electrical panel is faulty.	Check the electrical panel.
	A fuse in the machine is faulty.	Consult your dealer.
	The motor protection of the machine is switched off.	Consult your dealer.
The vacuum pump does not run at full speed.	The oil is too thick or contaminated.	Change the oil.
	The pump motor runs on two phases.	Check the voltage; if correct, consult your dealer.
The vacuum in the package is insufficient.	The programmed vacuum value is too high.	Lower the vacuum value in the program.
	The packaging material is of poor quality.	Select a better-quality packaging material.
	The product damages the bag.	Program a higher value for Soft-Air.
	The machine gases the package.	Turn off the gassing function.
The seal is leaking.	The package seam is poorly formed.	Increase the sealing time and/or reduce the MAP gas pressure.
	The package seam is burnt.	Decrease the sealing time.
	The opening of the vacuum bag is contaminated.	Try again and make sure that the opening of the bag stays clean.
	The sealing beam is dirty.	Clean the sealing beam.
	The Teflon lining of the sealing beam is damaged.	Replace the Teflon lining.
	The silicon rubber seal in the counter beam is damaged.	Replace the silicon rubber seal.
There is not enough gas in the bag.	The bag is too small.	Select a bigger bag.
	The programmed gas level is too low.	Increase the gas level value.
	The bag is not correctly positioned over the gas outlets.	Adjust the bag position.

Troubleshooting

The machine does not seal.	The bag is not correctly positioned over the sealing beam.	Adjust the bag position.
	The sealing wire is broken.	Replace the sealing wire.
	The thermal safety of the power supply was tripped.	Wait until the safety resets, which can take half an hour. Decrease the sealing time.
	The electrical contacts of the seal beam have fouled.	Remove the seal beam and clean the pins and contacts with sand paper.
The service symbol appears when turning on the machine, indicating the remaining production hours or cycles.	The service interval counters have reached their maximum programmed values.	To reset the service interval counters after the oil change: Start the machine and while the display shows the hours or cycles, press and hold the "X" button.

Parts Breakdown

Model VP-NL-0100-L 50000

Lid

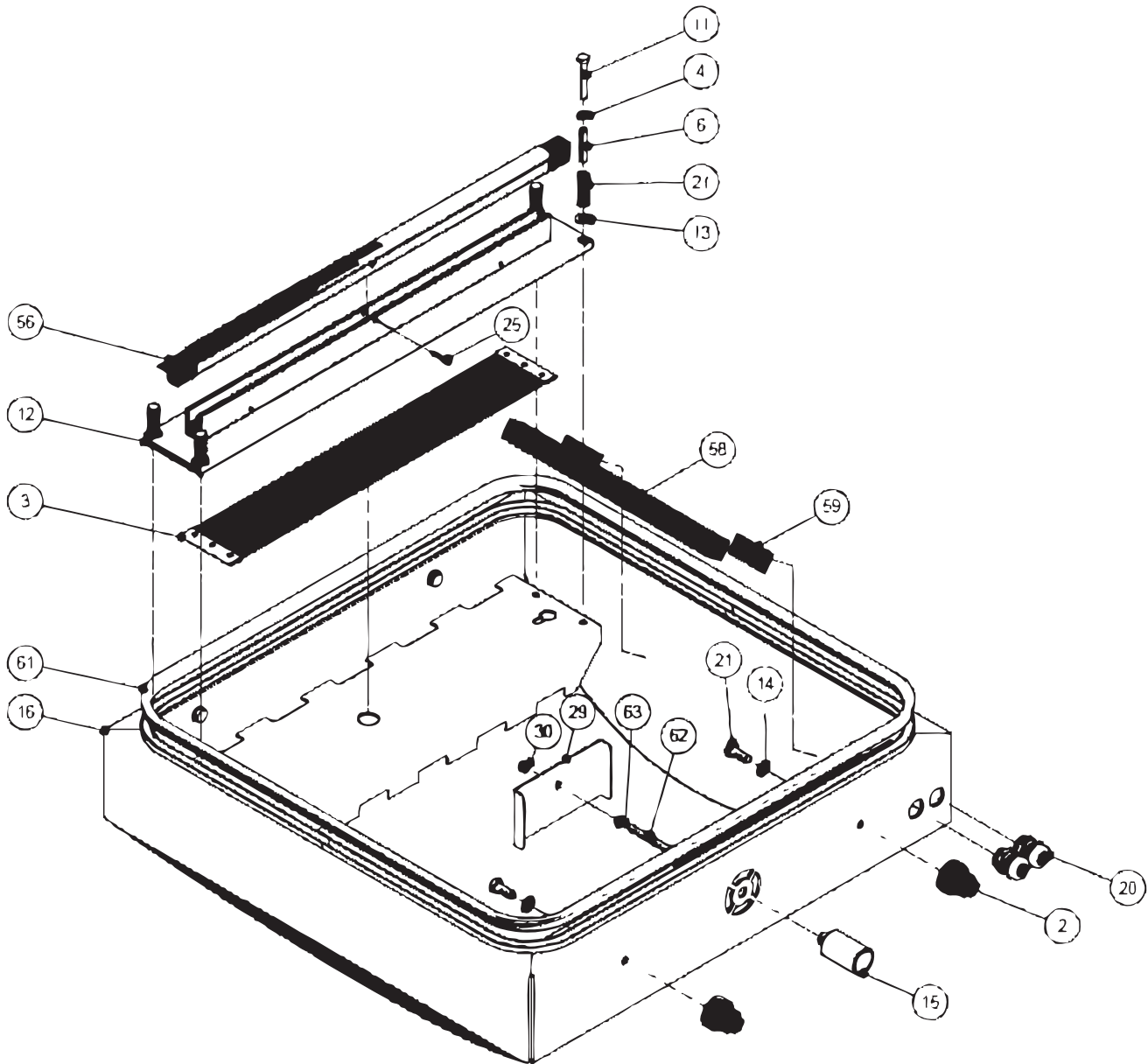

Parts Breakdown

Model VP-NL-0100-L 50000

Workplate

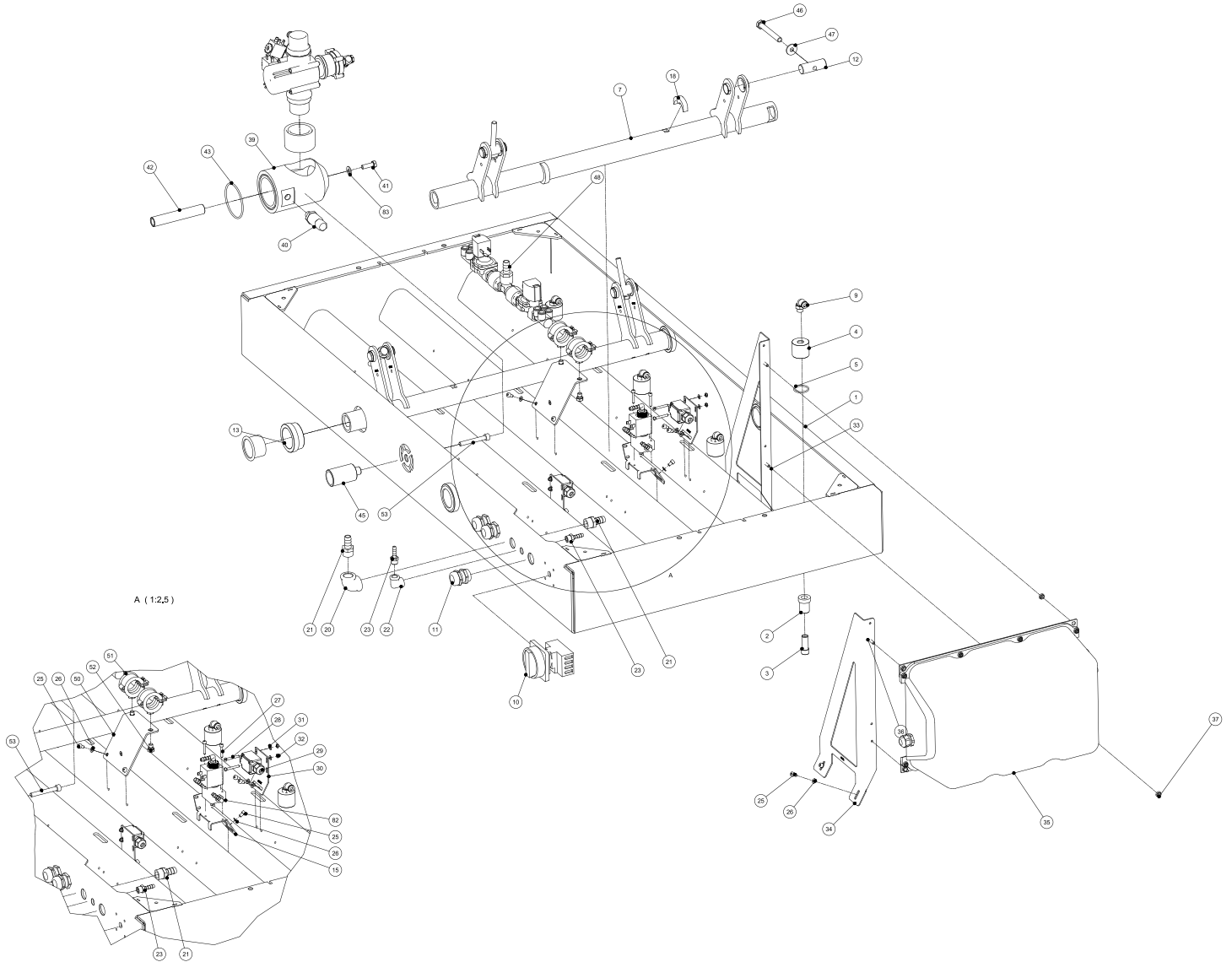

Parts Breakdown

Model VP-NL-0100-L 50000

Standard Assembly

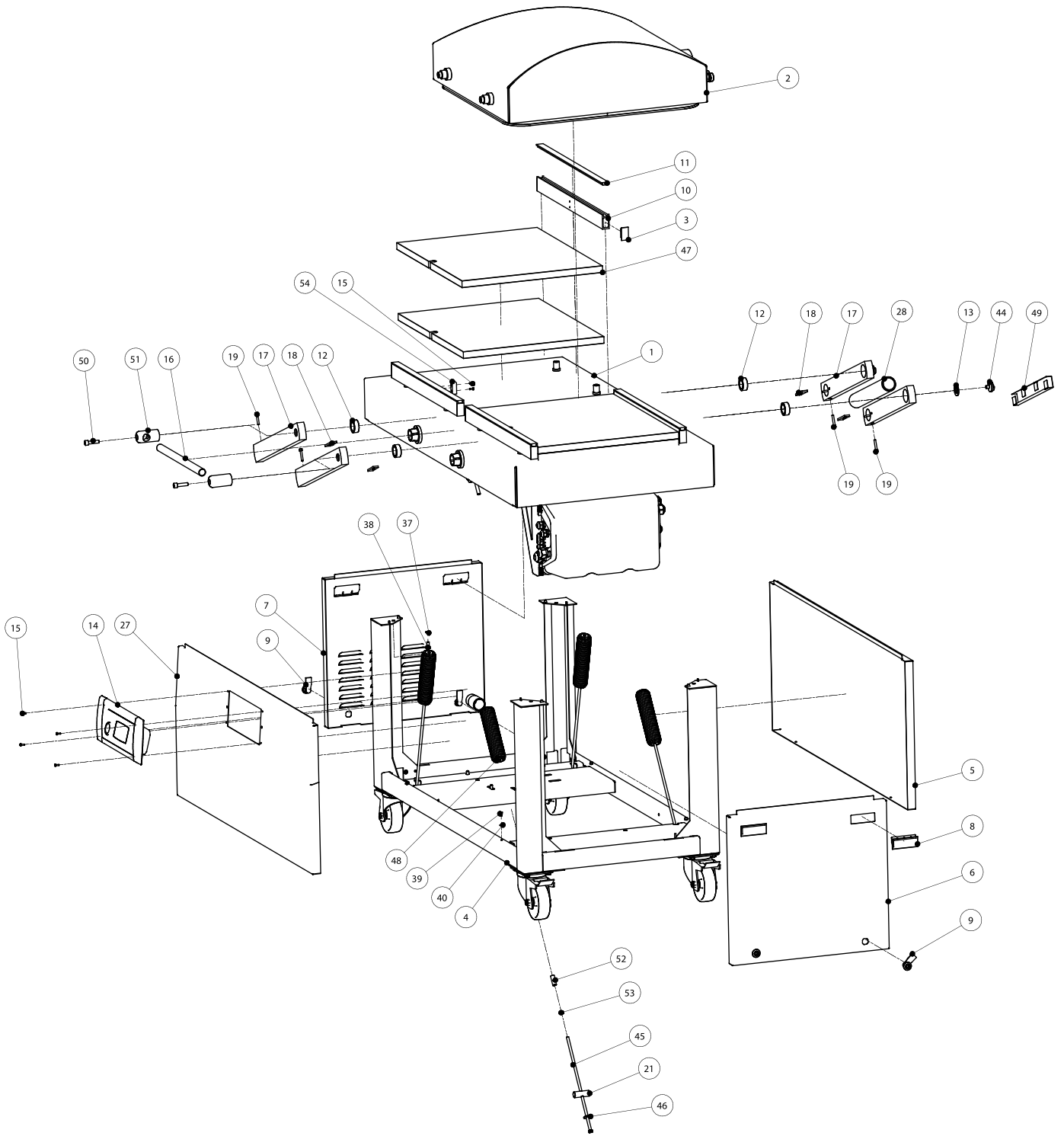

Parts Breakdown

Model VP-NL-0100-L 50000

Switch Box

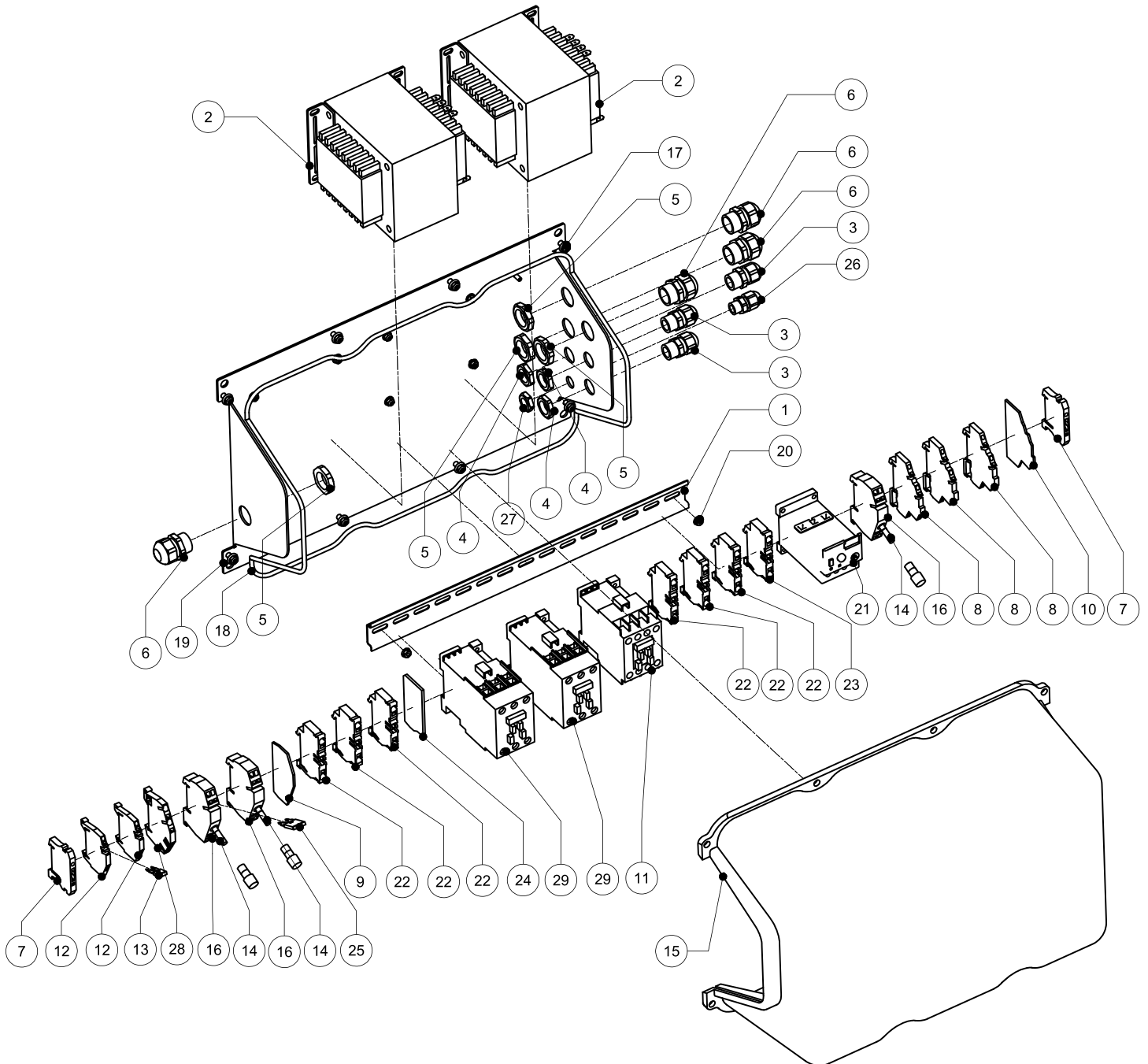

Parts Breakdown

Model VP-NL-0100-L 50000

Vacuum/Gas Pump

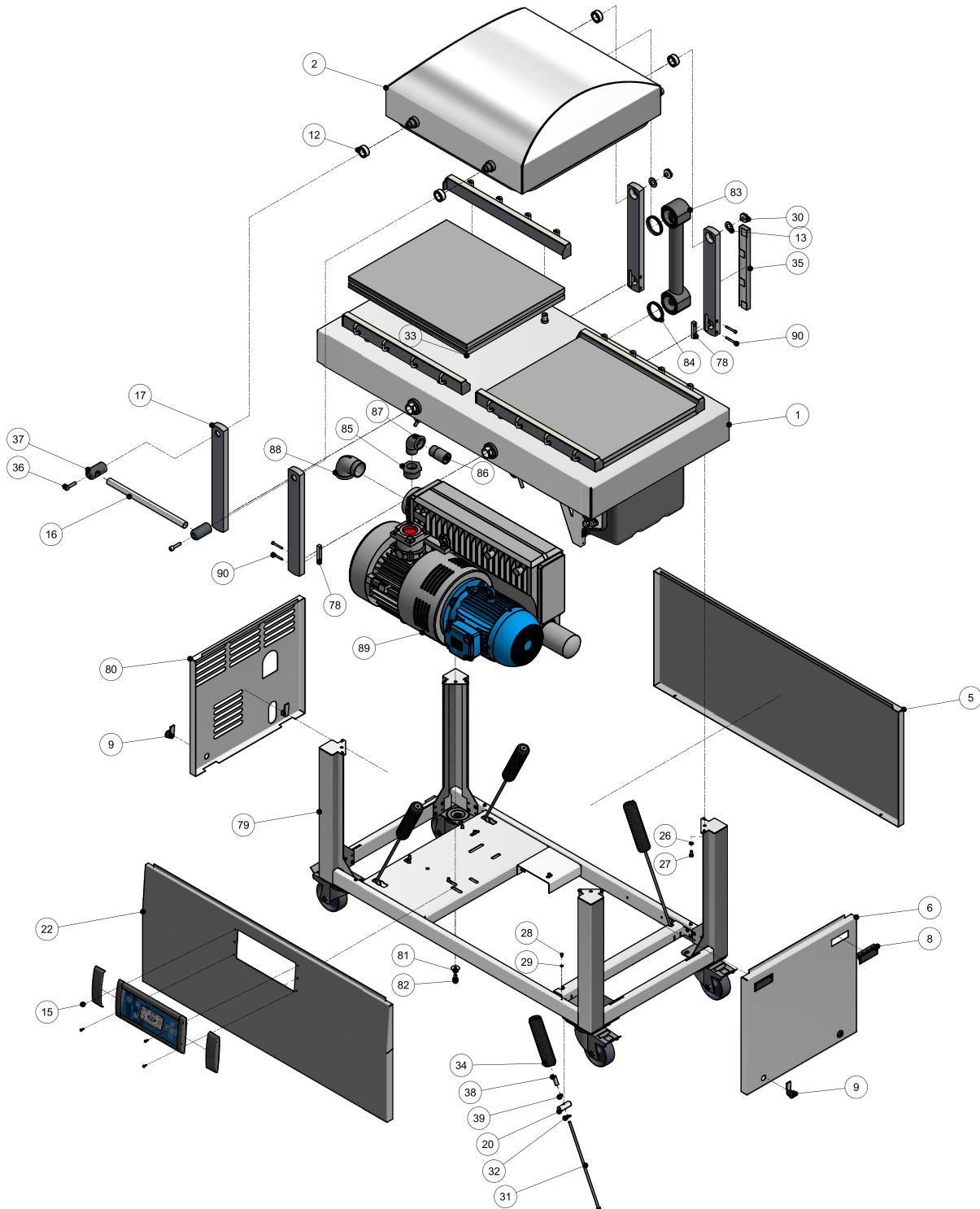

Parts Breakdown

Model VP-NL-0100-L 50000

Lid

Item No.	Description	Position	Item No.	Description	Position	Item No.	Description	Position
65680	Tap Lid DA for 50000	2	35948	Castle Washer Red Copper M10 for 50000	14	65683	Sealbalk A1015 Double Seal for 50000	56
15938	Sealbag 4002 L=550mm for 50000	3	62734	Bearing Busch Manifold DA for 50000	15	35936	Cable Channel 25x30 for 50000	58
35372	Castle Washer M8 for 50000	4	65682	D1 Deksel for 50000	16	62750	Acryltape Dubbelzijdig 25mm, L60mm for 50000	59
35919	Compression Spring Seal Mechanism for 50000	5	35831	Cable Gland M25x1.5 Brass for 50000	20	62742	Silicone Profile HD Model III 80 Deg Shore-A for 50000	61
35940	Tube STST 10x1x45mm for 50000	6	35941	Hexagon Screw M10x25 DIN933 A2 for 50000	21	62749	DIN 916 - M8x80 Hexagon Socket Set Screw for 50000	62
62745	ISO 4017 - M8x55 for 50000	11	35469	Hex.Socket Head Cap Screw M5x25 DIN912 A2 for 50000	25	35537	Self Locking Hexagon Nut M8 DIN985 A2 for 50000	63
65681	Seal Mechanism Assembly D1/M4-L for 50000	12	62747	Cover for Suction Hole for 50000	29			
35447	Castle Washer M10 for 50000	13	27814	Hexagon Nut M8 DIN934 A2 for 50000	30			

Workplate

Item No.	Description	Position	Item No.	Description	Position	Item No.	Description	Position
62688	Workplate for 50000	1	29997	Brass Hose Coupling 1/4x6 Ext. for 50000	23	65687	Vacuum Transmittor 0-1050MBAR for 50000	40
35821	Spacer Sil.Holder Gas 6mm for 50000	2	35272	Hex.Socket Head Cap Screw M5x8 DIN912 A2 for 50000	25	62736	ISO 4017 - M8x25 for 50000	41
35365	Mounting Screw Holing Block HD-03 for 50000	3	35214	Castle Washer M5 for 50000	26	62738	Mounting Pin Adapter Manifold DA for 50000	42
35507	Holing Block Siliconholder HD-03 for 50000	4	62726	ISO 4762 - M4x25 Hexagon Socket Head Cap Screw for 50000	27	62735	O-Ring 70x3mm for 50000	43
35364	O-Ring 27x2.5 for 50000	5	62727	M4x30 Slotted Cheese Head Screw for 50000	28	62734	Bearing Busch Manifold DA for 50000	45
65685	Parallel Axle D1 R2 for 50000	7	35468	Limit Switch with Cable for 50000	29	65688	Hex-Head Bolt - M10x80 for 50000	46
62717	Elbow Screwcoupling G 1/4x8 for 50000	9	62731	Da Montagesteun Eindschakelaar R2 for 50000	30	35219	Flat Washer M8 D9021 A2 for 50000	47
62718	Hoofdschakelaar H220-SE5494 (25A 3-POLIG) for 50000	10	35433	Castle Washer M4 for 50000	31	62729	Gas Supply Unit DA for 50000	48
35831	Cable Gland M25x1.5 Brass for 50000	11	35041	Hose Clip Klemfa 12.8x14.8mm for 50000	32	62728	Support for Gas Supply Unit DA for 50000	50
35534	Spring Axle Double Chamber for 50000	12	62733	Mounting Bracket Switch Box POS2 for 50000	33	35961	Suspension Clip BSA-8/29/33 for 50000	51
62720	Bearing Busch DA for 50000	13	62732	Mounting Bracket Switch Box POS1 for 50000	34	35220	Hexagon Screw M8x10 DIN933 A2 for 50000	52
62721	Universal Bracket DA for 50000	15	62719	Switchbox Model-I SC-DC for 50000	35	65689	Hexagon Socket Head Cap Screw M8x60 for 50000	53
62723	Schakelnok DA R2 for 50000	18	35481	Hex.Socket Head Cap Screw M5x16 DIN912 A2 for 50000	36	62730	Bearing 40x30 for 50000	81
62724	Knee 1/2 90 F-F AISI 316 for 50000	20	27782	Hexagon Flangenut M5 DIN6923 A2 for 50000	37	62722	3-2 Valve DC-XL Assembly for 50000	82
35841	Brass Hose Coupling 1/2x13 Ext. for 50000	21	65686	Vacuum Valve MB for 50000	38	65690	Rood Koper Ring ZCHT 8.5x18 for 50000	83
62725	Knee 1/4 F-F 90 Deg AISI316 for 50000	22	62739	Adapter for Manifold D4 for 50000	39	62587	Reducing Ring 63x40 BU/BI PVC for 50000	84

Parts Breakdown

Model VP-NL-0100-L 50000

Standard Assembly

Item No.	Description	Position	Item No.	Description	Position	Item No.	Description	Position
65691	Workplate D1 for 50000	1	35909	Skiffy Ring 21x37x3mm for 50000	13	35214	Castle Washer M5 for 50000	40
65682	Deksel D1 for 50000	2	45858	Control Panel (Holder Wide + PCB/TV/1-PROG) for 50000	14	62705	Blokkeerbout Parallelstang DA for 50000	44
35253	Closing Plug Silicon Holder for 50000	3	30026	Slott.Rais.Counter.Head Screw M4x12 DIN7985 A2 for 50000	15	62706	Zesk.Tabpout M8350 for 50000	45
65693	Frame D1 for 50000	4	65698	Handgriep M EN D1 for 50000	16	35219	Flat Washer M8 D9021 A2 for 50000	46
65694	Beplating D1 Achter for 50000	5	65699	Parallelstang D1 for 50000	17	41510	Filler Plate 1 Inch/25mm for 50000	47
65695	Beplating D1 Schakelkast for 50000	6	65700	Borgplaat Pallelstang for 50000	18	65703	Trekveer D1 for 50000	48
65696	Beplating D1 Pump for 50000	7	65701	ISO 4762 - M6x25 Hexagon Socket Head Cap Screw for 50000	19	62708	Kabeldoorvoer Parallelstang for 50000	49
35976	Handle Flat ABS Black for 50000	8	35534	Spring Axle Double Chamber for 50000	21	62709	M10x50 Cylinder Head Cap Screw DIN 912 for 50000	50
62692	Compression Locker E5-6-012-YY1 for 50000	9	65702	Beplating D1 Voor for 50000	27	62703	Montagebus Handvat DA for 50000	51
65697	Silicone Holder D1/M4-L for 50000	10	35236	Spring Ring M8 DIN127 A2 for 50000	37	35531	Pipe 13x1.5x34mm SS 304 for 50000	52
15842	Silicone Profile - 1M for 50000	11	35211	Hexagon Screw M8x16 DIN933 A2 for 50000	38	27814	Hexagon Nut M8 DIN934 A2 for 50000	53
35437	Bearing Cover Doublechamber for 50000	12	35272	Hex.Socket Head Cap Screw M5x8 DIN912 A2 for 50000	39	35834	Blocking Block Insert Plate for 50000	54

Switch Box

Item No.	Description	Position	Item No.	Description	Position	Item No.	Description	Position
65704	DIN-Rail 380mm for 50000	1	15771	Closed Contactor 24VAC for 50000	11	65710	EMBR AB193-ED1*P for 50000	21
15792	Combi-Trafo P200/460V-S24/32V for 50000	2	35687	Wire Clamp 2.5-2/2 AN for 50000	12	35318	Wireclamp 6-2/2 AN for 50000	22
65705	Wartel M16x1.5 KS for 50000	3	35688	Clamp Connector 2.5/2 for 50000	13	35317	Ground Terminal PE 6-10 for 50000	23
65706	Moer M16x1.5 KS for 50000	4	35307	Zekering Keram.5x20 2.5A Traag for 50000	14	65711	Sluitplaat PAP PDU 6/10 for 50000	24
65707	Moer M20x1.5 KS for 50000	5	35555	Cover Switchbox for 50000	15	65712	Doorverbinder ZQV 6/2 for 50000	25
35376	Cable Gland M20x1.5 Plastic for 50000	6	35306	Fuse Clamp 2.5-2/ZSI for 50000	16	65713	Wartel M12x1.5 KS for 50000	26
35305	End Fent for 50000	7	27782	Hexagon Flangenut M5 DIN6923 A2 for 50000	17	65714	Moer M12x1.5 KS for 50000	27
35315	Double Clamp 2.5-2 for 50000	8	35559	Micro Cellular Rubber 4mm Black for 50000	18	35304	Ground Terminal PE 4-2/3 for 50000	28
65708	Sluitplatt Zap ZDU 6-2 for 50000	9	65709	Montageplaat 2.5mm2 for 50000	19	15772	Contactor 24VAC for 50000	29
35323	Endplate Wireconnector for 50000	10	35041	Hose Clip Klemfa 12.8x14.8mm for 50000	20			

Parts Breakdown

Model VP-NL-0100-L 50000

Vacuum/Gas Pump

Item No.	Description	Position	Item No.	Description	Position	Item No.	Description	Position
65691	Workplate D1 for 50000	1	62704	Silicon Bar for 50000	25	27814	Hexagon Nut M8 DIN934 A2 for 50000	39
65682	D1 Deksel for 50000	2	35236	Spring Ring M8 DIN127 A2 for 50000	26	62712	Borgplaat Parallelstang R2 for 50000	78
65694	Beplating D1 Achter for 50000	5	35211	Hexagon Screw M8x16 DIN933 A2 for 50000	27	65733	Frame D1-160M3 Vacuum Pump for 50000	79
65695	Beplating D1 Schakelkast for 50000	6	35272	Hex.Socket Head Cap Screw M5x8 DIN912 A2 for 50000	28	65734	Plating Pumpsida D1-160M3 for 50000	80
35976	Handle Flat ABS Black for 50000	8	35214	Castle Washer M5 for 50000	29	27827	Flat Washer M10 D9021 A2 for 50000	81
62692	Compression Locker E5-6-012-YY1 for 50000	9	62705	Blokkeerbout Parallelstang DA for 50000	30	35444	Hexagon Screw M10x16 DIN933 A2 for 50000	82
35437	Bearing Cover Doublechamber for 50000	12	62706	Zesk.Tapbout M8350 for 50000	31	65735	Suction Tube D1 Assembled for 50000	83
35909	Skiffy Ring 21x37x3mm for 50000	13	35219	Flat Washer M8 D9021 A2 for 50000	32	62714	V-Ring Type V-070-A for 50000	84
45858	Control Panel (Holder Wide + PCB/TV/1-PROG) for 50000	14	41510	Filler Plate 1" / 25mm for 50000	33	65736	Reducing Ring 2"- 1.1/4" for 50000	85
30026	Slott.Rais.Counter.Head Screw M4x12 DIN7985 A2 for 50000	15	65703	Trekveer D1 for 50000	34	35879	Pipe Nipple Half 1.1/4x75 Complete for 50000	86
65698	Handgreep M EN D1 for 50000	16	62708	Kabeldoorvoer Parallelstang for 50000	35	65737	Elbow 1 1/4 INT/EXT NR92 for 50000	87
65732	Parallel Bar D1 for 50000	17	62709	M10x50 Cylinder Head Cap Screw DIN 912 for 50000	36	62711	Elbow 2" BI/BU RVS for 50000	88
35534	Spring Axle Double Chamber for 50000	20	62703	Montagebus Handvat DA for 50000	37	65738	Vacuumpump 160-132 230/400-3-50 for 50000	89
65702	Beplating D1 Voor for 50000	22	35531	Pipe 13x1.5x34mm Stainless Steel 304 for 50000	38	62715	M6x45 Hexagon Socket Head Screw ISO4762 for 50000	90

Parts Breakdown

Model VP-NL-0300-L 50001

Lid

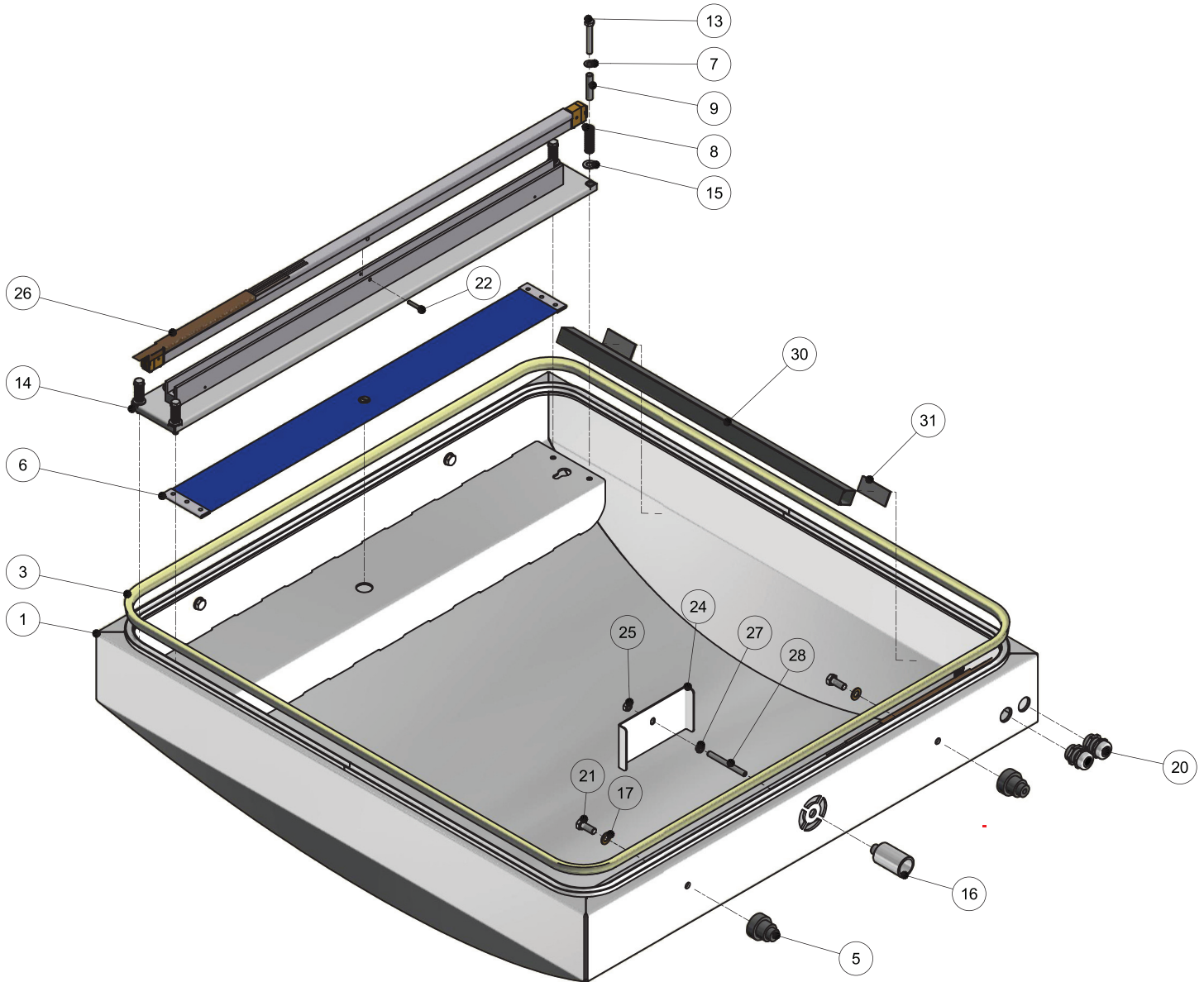

Parts Breakdown

Model VP-NL-0300-L 50001

Workplate

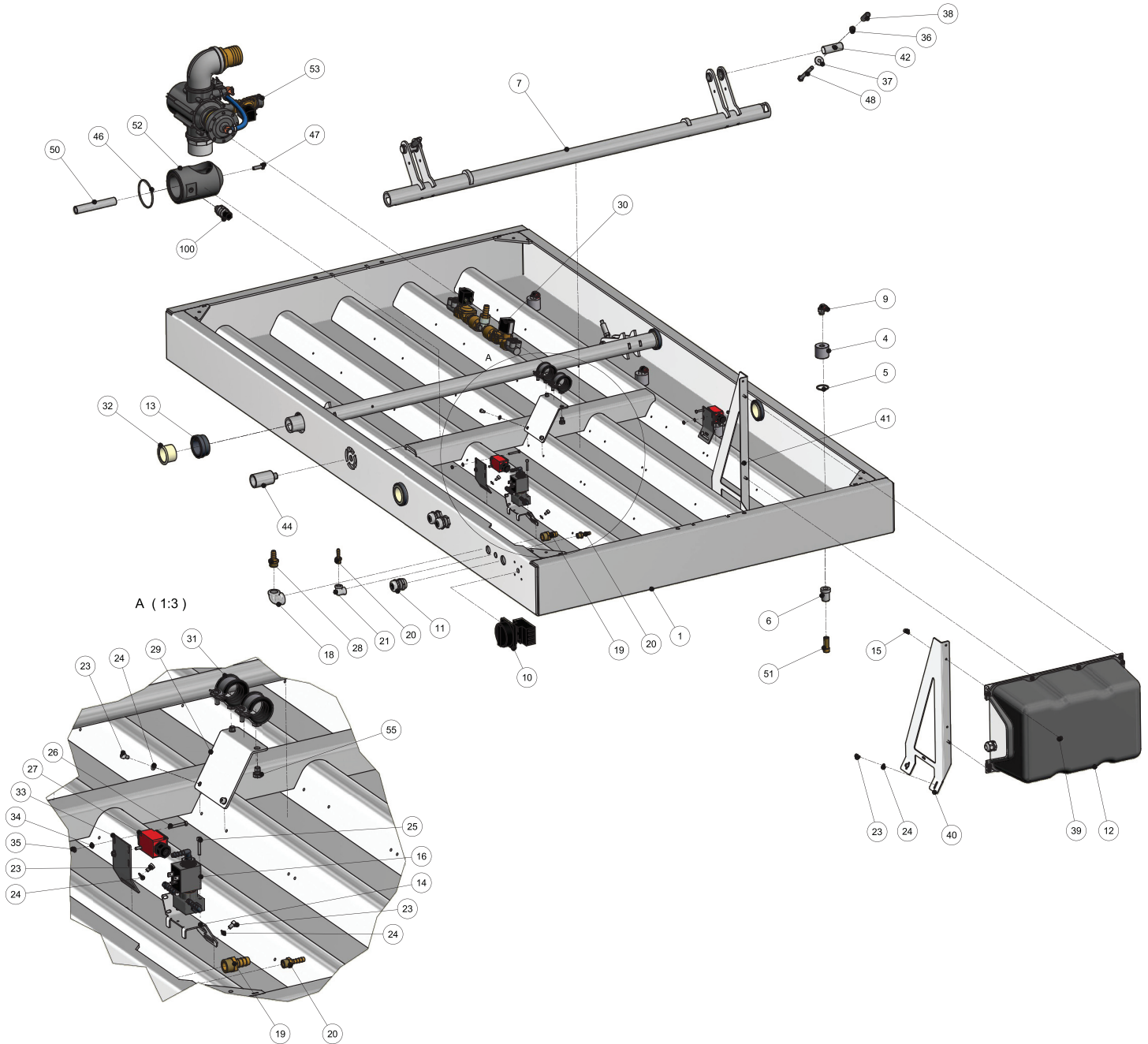

Parts Breakdown

Model VP-NL-0300-L 50001

Standard Assembly

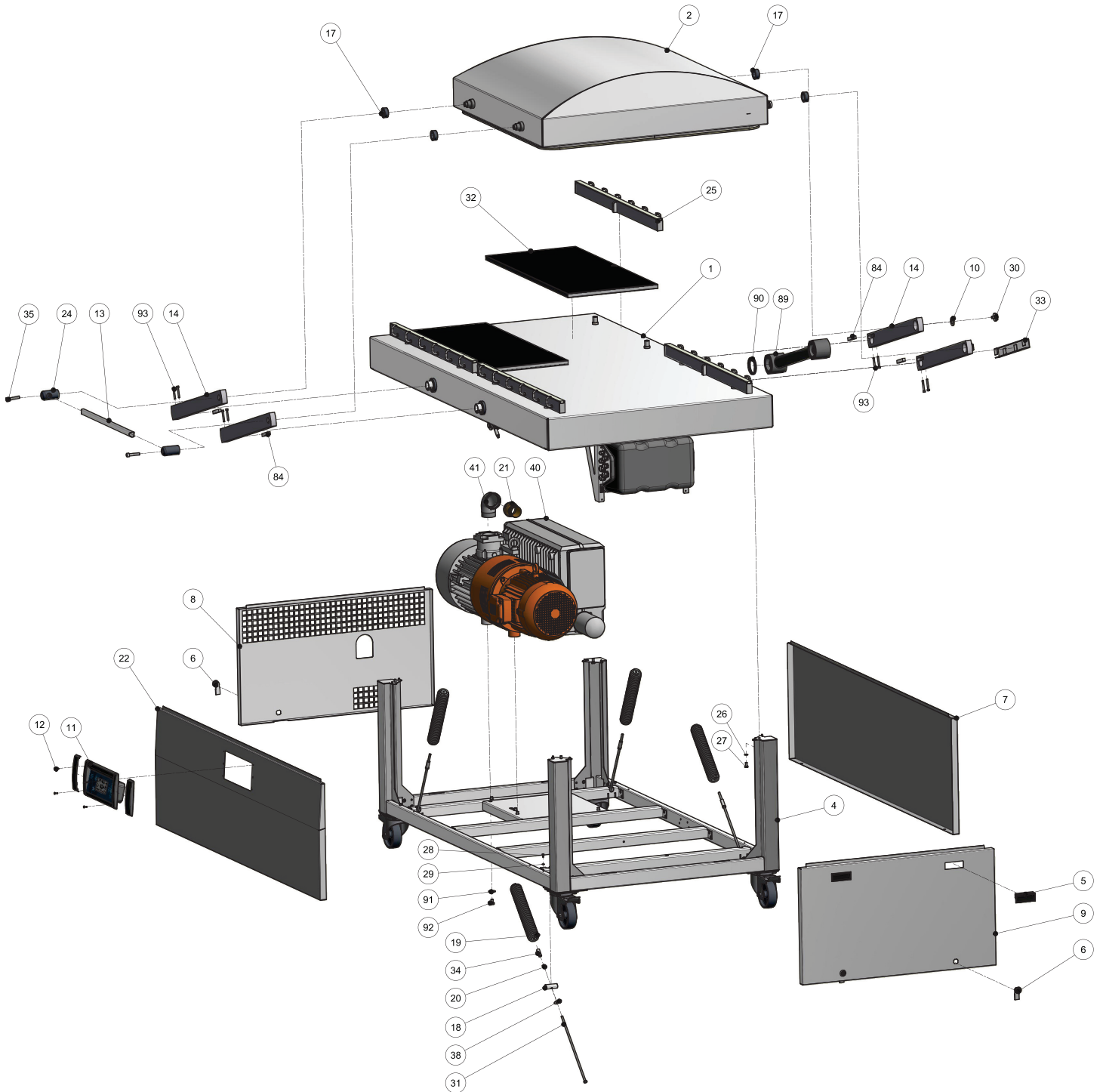

Parts Breakdown

Model VP-NL-0300-L 50001

Lid

Item No.	Description	Position	Item No.	Description	Position	Item No.	Description	Position
62689	Lid for 50001	1	62746	Seal Mechanism D4 Assembly for 50001	14	27814	Hexagon Nut M8 DIN934 A2 for 50001	25
62742	Silicone Profile HD Model III 80 Deg Shore-A for 50001	3	35447	Castle Washer M10 for 50001	15	62748	Sealbeam A1060 Double Seal for 50001	26
65680	Tap Lid DA for 50001	5	62734	Bearing Busch Manifold DA for 50001	16	35537	Self Locking Hexagon Nut M8 DIN985 A2 for 50001	27
62744	Sealzak E-493/E503/A-5000 for 50001	6	35948	Castle Washer Red Copper M10 for 50001	17	62749	Din 916 - M8x80 Hexagon Socket Set Screw for 50001	28
35372	Castle Washer M8 for 50001	7	35831	Cable Gland M25x1.5 Brass for 50001	20	35936	Cable Channel 25x30 for 50001	30
35919	Compression Spring Seal Mechanism for 50001	8	35941	Hexagon Screw M10x25 DIN933 A2 for 50001	21	62750	Acryltape Dubbelzijdig 25mm, L60mm for 50001	31
35940	Tube STST 10x1x45mm for 50001	9	35469	Hex.Socket Head Cap Screw M5x25 DIN912 A2 for 50001	22			
62745	ISO 4017 - M8x55 for 50001	13	62747	Cover for Suction Hole for 50001	24			

Workplate

Item No.	Description	Position	Item No.	Description	Position	Item No.	Description	Position
62688	Workplate for 50001	1	29997	Brass Hose Coupling 1/4x6 EXT. for 50001	20	35219	Flat Washer M8 D9021 A2 for 50001	37
35507	Holing Block Siliconholder HD-03 for 50001	4	62725	Knee 1/4 F-F 90Deg AISI316 for 50001	21	35531	Pipe 13x1.5x34mm Stainless Steel 304 for 50001	38
35364	O-Ring 27x2.5 for 50001	5	35272	Hex.Socket Head Cap Screw M5x8 DIN912 A2 for 50001	23	27782	Hexagon Flangenut M5 DIN6923 A2 for 50001	39
35821	Spacer Sil.Holder Gas 6mm for 50001	6	35214	Castle Washer M5 for 50001	24	62732	Mounting Bracket Switch Box POS1 for 50001	40
62716	D4 Parallel-Axle for 50001	7	62726	ISO 4762 - M4x25 Hexagon Socket Head Cap Screw for 50001	25	62733	Mounting Bracket Switch Box POS2 for 50001	41
62717	Elbow Screw Coupling G 1/4x8 for 50001	9	62727	M4x30 Slotted Cheese Head Screw for 50001	26	35534	Spring Axle Double Chamber for 50001	42
62718	Hoofdschakelaar H220-SE5494 (25A 3-POLIG) for 50001	10	35468	Limit Switch with Cable for 50001	27	62734	Bearing Busch Manifold DA for 50001	44
35831	Cable Gland M25x1.5 Brass for 50001	11	35248	Hose Coupling 1/2x10 EXT. for 50001	28	62735	O-Ring 70x3mm for 50001	46
62719	Switchbox Model-I SC-DC for 50001	12	62728	Support for Gas Supply Unit DA for 50001	29	62736	ISO 4017 - M8x25 for 50001	47
62720	Bearing Busch DA for 50001	13	62729	Gas Supply Unit DA for 50001	30	62737	ISO 4017 - M8x80 for 50001	48
62721	Universal Bracket DA for 50001	14	35961	Suspension Clip BSA-8/29/33 for 50001	31	62738	Mounting Pin Adapter Manifold DA for 50001	50
35481	Hex.Socket Head Cap Screw M5x16 DIN912 A2 for 50001	15	62730	Bearing 40x30 for 50001	32	35365	Mounting Screw Holing Block HD-03 for 50001	51
62722	3-2 Valve DC-XL Assembly for 50001	16	62731	Da Montagesteun Eindschakelaar R2 for 50001	33	62739	Adapter for Manifold D4 for 50001	52
62723	Schakelnok DA R2 for 50001	17	35433	Castle Washer M4 for 50001	34	62740	Vacuum Valve D4 for 50001	53
62724	Knee 1/2 90 F-F AISI 316 for 50001	18	35411	Hexagon Nut M4 DIN934 A2 for 50001	35	35220	Hexagon Screw M8x10 DIN933 A2 for 50001	55
35841	Brass Hose Coupling 1/2x13 EXT. for 50001	19	27814	Hexagon Nut M8 DIN934 A2 for 50001	36	62741	Vacuum Transmitter with Earth Connection for 50001	100

Parts Breakdown

Model VP-NL-0300-L 50001

Standard Assembly

Item No.	Description	Position	Item No.	Description	Position	Item No.	Description	Position
62688	Workplate for 50001	1	35534	Spring Axle Double Chamber for 50001	18	62708	Kabeldoorboer Parallelstang for 50001	33
62689	Lid for 50001	2	62700	Pull Spring D4 for 50001	19	35531	Pipe 13x1.5x34mm Stainless Steel 304 for 50001	34
65739	Frame for 50001	4	27814	Hexagon Nut M8 DIN934 A2 for 50001	20	62709	M10x50 Cylinder Head Cap Screw DIN 912 for 50001	35
35976	Handle Flat ABS Black for 50001	5	62701	Brass Coupling 2x50 EXT for 50001	21	35219	Flat Washer M8 D9021 A2 for 50001	38
62692	Compression Locker E5-6-012-YY1 for 50001	6	62702	Beplating D4 Voor for 50001	22	62710	RA_0302_D for 50001	40
62693	Beplating D4 Achter for 50001	7	62703	Montagebus Handvat DA for 50001	24	62711	Elbow 2" BI/BU RVS for 50001	41
62694	Plating Pump Side D4 for 50001	8	62704	Silicon Bar for 50001	25	62712	Borgplaat Parallelstang R2 for 50001	84
62695	Beplating D4 Schakelkast for 50001	9	35236	Spring Ring M8 DIN127 A2 for 50001	26	62713	Suction Tube GK293 Assembled for 50001	89
35909	Skiffy Ring 21x37x3mm for 50001	10	35211	Hexagon Screw M8x16 DIN933 A2 for 50001	27	62714	V-Ring Type V-070-A for 50001	90
45858	Control Panel (Holder Wide + PCB/TV/1-PROG) for 50001	11	35272	Hex.Socket Head Cap Screw M5x8 DIN912 A2 for 50001	28	27827	Flat Washer M10 D9021 A2 for 50001	91
30026	Slott.Rais.Counter.Head Screw M4x12 DIN7985 A2 for 50001	12	35214	Castle Washer M5 for 50001	29	35444	Hexagon Screw M10x16 DIN933 A2 for 50001	92
62697	Handgreep D4 for 50001	13	62705	Blokkeerbout Parallelstang DA for 50001	30	62715	M6x45 Hexagon Socket Head Screw ISO4762 for 50001	93
62698	Parallelstang D4 R2 for 50001	14	62706	Zesk.Tapbout M8350 for 50001	31			
35437	Bearing Cover Doublechamber for 50001	17	62707	Insertplate D4 for 50001	32			

Parts Breakdown

Model VP-NL-0063-L 50002

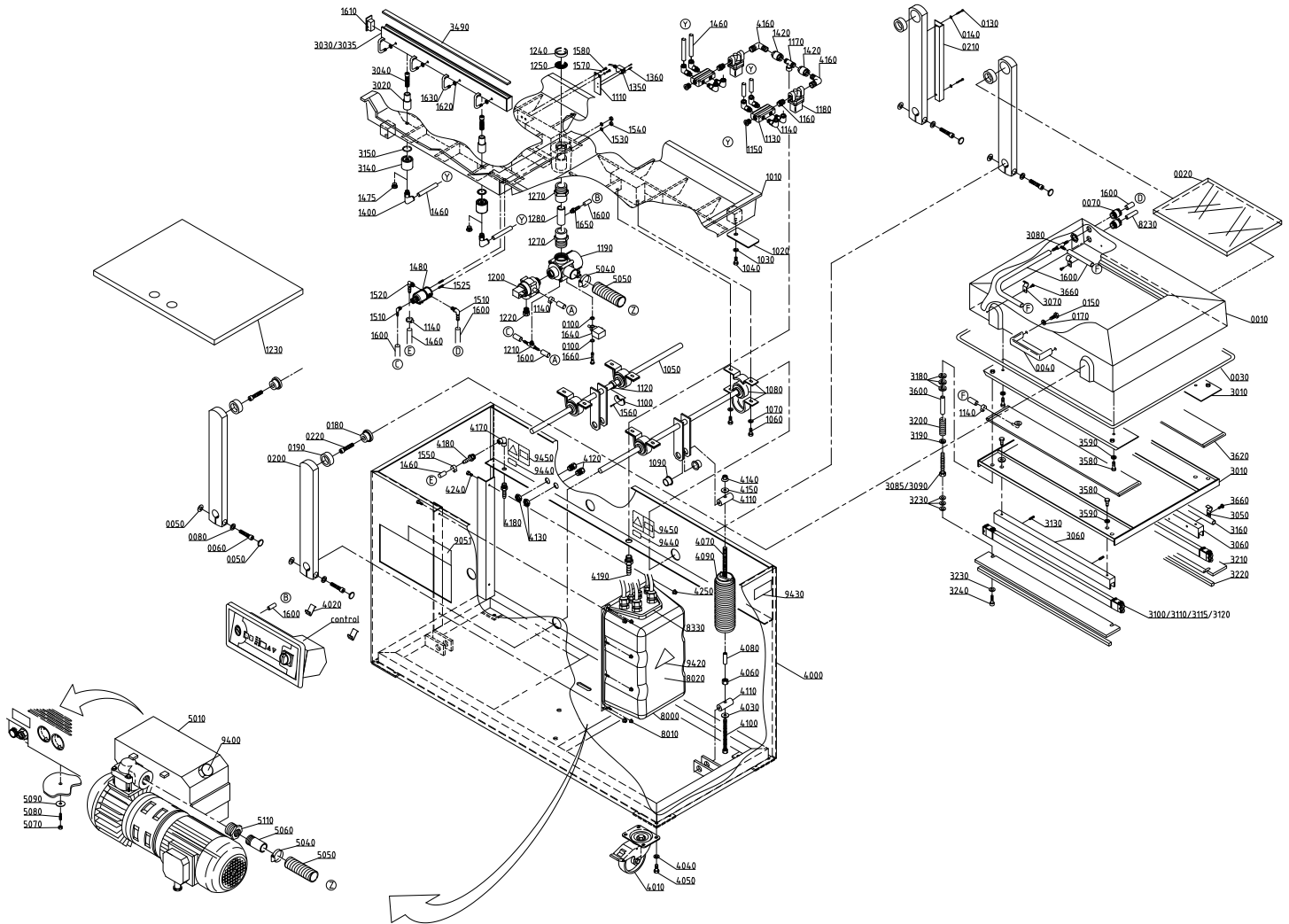

Parts Breakdown

Model VP-NL-0063-L 50002

Item No.	Description	Position	Item No.	Description	Position	Item No.	Description	Position
35423	Vacuum Cover Complete for 50002	0010	35255	Distribution Block 4DVB/VP 3/8"-1/4"-4 for 50002	1130	30005	Hexagon Screw M6x12 Din933 A2 for 50002	1580
35290	Sight Glass (380x280x20) for 50002	0020	35249	Elbow Coupling 10x1/4" for 50002	1140	27837	Hose (O2) Drago 6x13 for 50002	1600
35105	Sil.Profile Lid Gasket 8mm 60°SH/25MTR for 50002	0030	35258	Blind Plug 3/8" MS/VN for 50002	1150	35253	Closing Plug Silicon Holder for 50002	1610
35299	Handle GN-565-26-192-SW 800 for 50002	0040	35254	Reducing Nipple 1/2"x3/8" for 50002	1160	35251	Hexagon Nut M8x1 Low Din439B for 50002	1620
35427	Plug GN-340 for 50002	0050	35457	T-Piece 1/2x1/2x1/2 BU/BU/BI for 50002	1170	35250	Gas Nozzle Universal for 50002	1630
35428	Hex.Socket Head Cap Screw M12x35 Din912 A2 for 50002	0060	35252	Gas Valve for Gas Distribute Pot for 50002	1180	35488	3-Way Valve Soft-Air New for 50002	1640
35298	Cable Gland M20x1,5 Brass for 50002	0070	15722	Vacuum Valve without Decomp.Head 32mm for 50002	1190	27820	Right Hose Coupling 1/8"x6 Ext. for 50002	1650
35430	Spring Ring Cheese Head M12 Din7980 A2 for 50002	0080	15723	Decompress Head Vacuum Valve 32mm for 50002	1200	35490	Single Banjo Bolt 1/8" for 50002	1660
35431	Sealing Washer 0251796/0251797 for 50002	0100	35282	T-Screw-in Hose Coupling 1/8"x6 Ext. for 50002	1210	35491	Sealing Mechanism for 50002	3010
35432	Slotted Cheese Head Screw M4x8 A2 Din84 for 50002	0130	15751	Decompress Filter 1/2" for 50002	1220	35492	Spacer Sil.Holder Gas 35mm for 50002	3020
35433	Castle Washer M4 for 50002	0140	41483	Filler Plate 1"/25mm for 50002	1230	35493	Silicon Holder for 50002	3030
35300	Hexagon Screw M8x20 Din933 A2 for 50002	0150	35464	Filter Gauze Clip Ring for 50002	1240	35494	Silicon Holder for 50002	3035
35301	Castle Washer Red Copper M8 for 50002	0170	35465	Filter for 50002	1250	35365	Mounting Screw Holing Block HD-03 for 50002	3040
35436	Shaft Journal Cover for 50002	0180	35466	PVC Nipple BEA 40x32x1 for 50002	1270	35355	Cable Clip 1x10mm Din72571 for 50002	3050
35437	Bearing Cover Double Chamber for 50002	0190	35467	PVC Tube Round 32 L=80mm for 50002	1280	35497	Pressure Beam for 50002	3060
35438	Parallel Rod for 50002	0200	35468	Limit Switch with Cable for 50002	1350	35352	Cable Clamp 1x12mm Din7257 for 50002	3070
35439	Clamping Profile Parallel Rod for 50002	0210	35469	Hex.Socket Head Cap Screw M5x25 Din912 A2 for 50002	1360	27836	Connecting Piece T-Piece 6mm for 50002	3080
35440	Hex.Socket Head Cap Screw M8x30 Din912 A2 for 50002	0220	35249	Elbow Coupling 10x1/4" for 50002	1400	35500	Hexagon Screw M8x70 Din933 A2 for 50002	3085
35441	Vacuum Chamber Complete for 50002	1010	35471	Non-Return Valve 1/2 for 50002	1420	35501	Hexagon Screw M8x70 + M4 for 50002	3090
35442	Clamping Plate Vacuum Chamber for 50002	1020	35256	Air Pressure Hose Blue 10x8 for 50002	1460	35502	Seal Beam DS/1/655 for 50002	3100
27827	Flat Washer M10 D9021 A2 for 50002	1030	35247	Blind Stopper + O-Ring 1/4" MS/VN for 50002	1475	35503	Seal Beam TS/1/655 for 50002	3110
35444	Hexagon Screw M10x16 Din933 A2 for 50002	1040	15716	3-Way Valve for 50002	1480	35504	Seal Beam S2/1/655 for 50002	3115
35445	Parallel Axle for 50002	1050	30015	Square Hose Coupling 1/4"x6 Ext. for 50002	1510	35505	Seal Beam 8mm/1/655 for 50002	3120
35446	Hex.Socket Head Cap Screw M10x30 Din912 VZ for 50002	1060	35476	Square Hose Coupling 1/4"x8 Ext. for 50002	1520	27788	Adj.Screw/Soc.Head M6x25 Din916 A2 for 50002	3130
35447	Castle Washer M10 for 50002	1070	35477	Adj.Sxrew/Soc.Head M4x20 Din916 A2 for 50002	1525	35507	Holing Block Silicon Holder HD-03 for 50002	3140
35448	Support Bearing for 50002	1080	34998	Flat Washer M4 D9021 A2 for 50002	1530	35364	O-Ring 27x2.5 for 50002	3150
35449	Bearing Ring PAF-20115-P10 for 50002	1090	35411	Hexagon Nut M4 Din934 A2 for 50002	1540	35509	Tube Alu 10x1mm L=540mm for 50002	3160
35450	Switch Disc 3 for 50002	1100	35480	Hose Clip ABA 11-17mm for 50002	1550	35447	Castle Washer M10 for 50002	3180
35451	Switch Plate Double Chamber for 50002	1110	35481	Hex.Socket Head Cap Screw M5x16 Din912 A2 for 50002	1560	35372	Castle Washer M8 for 50002	3190
35452	Adjusting Ring 30mm for 50002	1120	27786	Flat Washer M6 D9021 A2 for 50002	1570	35512	Compression Spring Sealing Mechanism for 50002	3200

Parts Breakdown

Model VP-NL-0063-L 50002

Item No.	Description	Position	Item No.	Description	Position	Item No.	Description	Position
35513	Vacuum Bag Holder for 50002	3210	35539	Elbow 1/2" Ext/Ext Brass Nickle for 50002	4160	35399	Upper Sticker Turbovac 03 for 50002	9051
35105	Sil.Profile Lid Gasket 8mm 60°SH/25MTR for 50002	3220	35413	Elbow 1/4" Int Brass for 50002	4170	35400	Packing Cover Control + Glue-Layer for 50002	9060
34998	Flat Washer M4 D9021 A2 for 50002	3230	35261	Brass Hose Coupling 1/4"x8 Ext. for 50002	4180	30010	Brass Nut 1/4" for 50002	9070
35383	Slotted Cheese Head Screw M4x16 A2 Din84 for 50002	3240	35248	Hose Coupling 1/2"x10 Ext. for 50002	4190	35402	Square Hose Coupling 1/8"x4 Ext. for 50002	9080
15842	Silicone T-Profil 40 Shore One Meter for 50002	3490	35481	Hex.Socket Head Cap Screw M5x16 Din912 A2 for 50002	4240	35403	Plastic Checknut PG 16 for 50002	9090
30005	Hexagon Screw M6x12 Din933 A2 for 50002	3580	27782	Hexagon Flangenut M5 Din6923 A2 for 50002	4250	35404	Cover Control Box for 50002	9100
27824	Castle Washer M6 for 50002	3590	35387	Vac Pump 040-132 230/400-3-50 E for 50002	5010	35571	Cross Recessed Raised Cheese Head Screw M3.5x10 for 50002	9110
35520	Tube STST 10x1x60mm for 50002	3600	35388	Hose Clip ABA 32-44mm for 50002	5040	35406	Cable Gland PG16 IP65 Plastic for 50002	9120
35521	Seal Bag 2" L=480mm for 50002	3620	15833	PVC Suction Hose HNA-32x42mm for 50002	5050	35407	Sealing Washer 0-1/4 for 50002	9130
35353	Self Tapping Screw PIAS 3.5x9.5 for 50002	3660	35390	Pipe Nipple Half 1/2 1" for 50002	5060	35408	Reducing Ring 1/4"x1/8" for 50002	9140
35523	Bottom Section for 50002	4000	27814	Hexagon Nut M8 Din934 A2 for 50002	5070	27819	Square Hose Coupling 1/8"x6 Ext for 50002	9150
35369	Swivel Castor Black ST.ST. 100m for 50002	4010	35391	Adj.Screw/Soc.Head M8x25 Din916 A2 for 50002	5080	34998	Flat Washer M4 D9021 A2 for 50002	9160
35368	Spring Control Box for 50002	4020	35219	Flat Washer M8 D9021 A2 for 50002	5090	35411	Hexagon Nut M4 Din934 A2 for 50002	9170
35219	Flat Washer M8 D9021 A2 for 50002	4030	35552	Reducing Ring 1 1/4"x1" for 50002	5110	35578	Locking Profile Control Basic for 50002	9180
35372	Castle Washer M8 for 50002	4040	62687	Control Unit DS 3-400V 4A 2x24V for 50002	8000	35579	Vacuum Meter 40mm for 50002	9190
35220	Hexagon Screw M8x10 Din933 A2 for 50002	4050	27782	Hexagon Flange Nut M5 Din6923 A2 for 50002	8010	35413	Elbow 1/4" Int Brass for 50002	9200
27814	Hexagon Nut M8 Din934 A2 for 50002	4060	35555	Cover Switch Box for 50002	8020	29997	Brass Hose Coupling 1/4"x6 Ext. for 50002	9210
35530	Stud M8x160 DK for 50002	4070	35556	Seal Cord C1-08 for 50002	8230	35415	Plug Blac R5 for 50002	9310
35531	Pipe 13x1,5x34mm Stainless Steel 304 for 50002	4080	35557	Valve Cord CC2-06 for 50002	8240	35416	Plug Blac R6 for 50002	9320
35532	Tension Spring for 50002	4090	35329	Pump Cord CM4-09 for 50002	8250	35417	Plug Blac R10 for 50002	9330
35533	Hexagon Screw M8x400 A2 for 50002	4100	35559	Microcellular Rubber 4mm Black for 50002	8330	15712	Hydraulic Oil for 3-Phase Vacuum Pump (060510) for 50002	9400
35534	Spring Axle Double Chamber for 50002	4110	35394	Control 03-Turbovac for 50002	9010	27795	Sticker Tension Triangle for 50002	9420
35298	Cable Gland M20x1,5 Brass for 50002	4120	35395	Control Turbovac Basic for 50002	9011	27794	Sticker Machine Type for 50002	9430
35375	Nut M20x1.5 MS for 50002	4130	35396	Packing Control + Glue-Layer for 50002	9020	35223	Sticker 19x38 Yellow for 50002	9440
35537	Self Locking Hexagon Nut M8 Din985 A2 for 50002	4140	15780	Switch-Disconnecter Tripolar 25A Front for 50002	9040	35224	Sticker 98x65 Yellow for 50002	9450
35372	Castle Washer M8 for 50002	4150	35398	Control Panel Holder Turbovac for 50002	9050			

Electrical Schematics

Model VP-NL-0100-L 50000

Model VP-NL-0300-L 50001

Model VP-NL-0063-L 50002

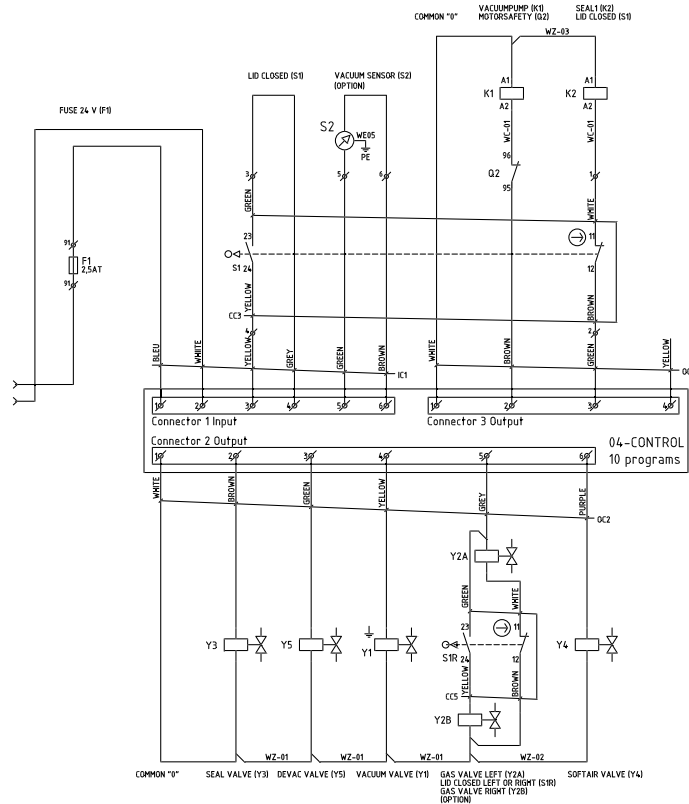
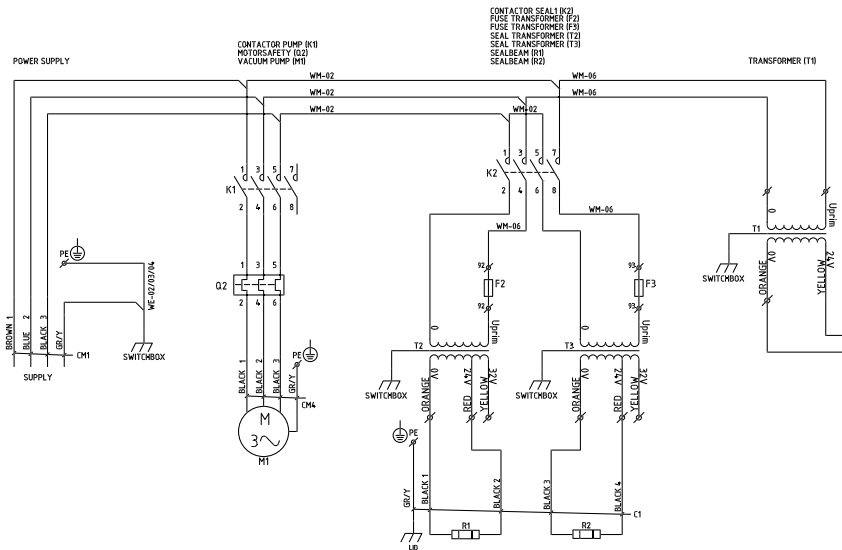

Notes



Warranty Registration

Thank you for purchasing an Omcan product. To register your warranty for this product, complete the information below, tear off the card at the perforation and then send to the address specified below. You can also register online by visiting:

Merci d'avoir acheté un produit Omcan. Pour enregistrer votre garantie pour ce produit, complétez les informations ci-dessous, détachez la carte au niveau de la perforation, puis l'envoyer à l'adresse spécifiée ci-dessous. Vous pouvez également vous inscrire en ligne en visitant:

Gracias por comprar un producto Omcan usted. Para registrar su garantía para este producto, complete la información a continuación, cortar la tarjeta en la perforación y luego enviarlo a la dirección indicada a continuación. También puede registrarse en línea en:

<https://omcan.com/warranty-registration/>

For mailing in Canada

Pour postale au Canada

Por correo en Canadá

OMCAN

PRODUCT WARRANTY REGISTRATION

3115 Pepper Mill Court,

Mississauga, Ontario

Canada, L5L 4X5

For mailing in the US

Pour diffusion aux États-Unis

Por correo en los EE.UU.

OMCAN

PRODUCT WARRANTY REGISTRATION

4450 Witmer Industrial Estates, Unit 4,

Niagara Falls, New York

USA, 14305

or email to: service@omcan.com



Purchaser's Information

Name: _____

Address: _____

City: _____ Province or State: _____ Postal or Zip: _____

Country: _____

Dealer from which Purchased: _____

Dealer City: _____ Dealer Province or State: _____

Invoice: _____

Model Name: _____ Model Number: _____

Machine Description: _____

Date of Purchase (MM/DD/YYYY): _____

Would you like to extend the warranty? Yes No

Company Name: _____

Telephone: _____

Email Address: _____

Type of Company:

Restaurant Bakery Deli

Butcher Supermarket Caterer

Institution (specify): _____

Other (specify): _____

Serial Number: _____

Date of Installation (MM/DD/YYYY): _____

Thank you for choosing Omcan | Merci d'avoir choisi Omcan | Gracias por elegir Omcan



Since 1951 Omcan has grown to become a leading distributor of equipment and supplies to the North American food service industry. Our success over these many years can be attributed to our commitment to strengthen and develop new and existing relationships with our valued customers and manufacturers. Today with partners in North America, Europe, Asia and South America, we continually work to improve and grow the company. We strive to offer customers exceptional value through our qualified local sales and service representatives who provide convenient access to over 6,500 globally sourced products.

Depuis 1951 Omcan a grandi pour devenir un des “leaders” de la distribution des équipements et matériel pour l’industrie des services alimentaires en Amérique du Nord. Notre succès au cours de ces nombreuses années peut être attribué à notre engagement à renforcer et à développer de nouvelles et existantes relations avec nos clients et les fabricants de valeur. Aujourd’hui avec des partenaires en Amérique du Nord, Europe, Asie et Amérique du Sud, nous travaillons continuellement à améliorer et développer l’entreprise. Nous nous efforçons d’offrir à nos clients une valeur exceptionnelle grâce à nos ventes locales qualifiées et des représentants de service qui offrent un accès facile à plus de 6500 produits provenant du monde entier.

Desde 1951 Omcan ha crecido hasta convertirse en un líder en la distribución de equipos y suministros de alimentos en América del Norte industria de servicios. Nuestro éxito en estos años se puede atribuir a nuestro compromiso de fortalecer y desarrollar nuevas relaciones existentes con nuestros valiosos clientes y fabricantes. Hoy con socios de América del Norte, Europa, Asia y América del Sur, que trabajan continuamente para mejorar y crecer la empresa. Nos esforzamos por ofrecer a nuestros clientes valor excepcional a través de nuestro local de ventas y representantes de los servicios que proporcionan un fácil acceso a más de 6,500 productos con origen a nivel mundial.

